

OFFICIAL TOURNAMENT RULES

(Effective February 20, 2009)



Questions of interpretation and suggestions for improvement or changes in the rules should be forwarded to the AWSA Rules Committee.

These rules supersede all previous rules and shall remain in effect until an amended edition of the rules (or a new Official Tournament Rule Book) is published. Important information concerning updates and interpretations may be found on the website.

*All rules changes subsequent to the 2008 Rule Book are written in **italics***

USA Water Ski
1251 Holy Cow Road
Polk City, Florida 33868-8200
800-533-2972 • 863-324-4341 phone • 863-325-8259 fax
E-mail: competition@usawaterski.org
Website: USAWATERSKI.org

American Water Ski Association
Official Tournament Rules

Table of Contents

Rule 1 - General	1
Rule 2 - Tournament Events, Entry, Registration, Order of Contestants ...	4
Rule 3 - Divisions of Competition and Performance Requirements	6
Rule 4 - Tournament Qualification Requirements	9
Rule 5 - Overall and Team Competition.....	10
Rule 6 - Officials	13
Rule 7 - Rerides, Protests and Disqualification	19
Rule 8 - Equipment and Definitions	21
Rule 9 - Jumping	27
Rule 10 - Slalom	39
Rule 11 - Tricks	51
Rule 12 - Safety Requirements	61
Rule 13 - Optional Tournament Formats	63
Rule 14 - Records	65
Rule 15 - Record Capability Tournaments	67
Rule 16 - Cash Prize Tournaments	72

Appendix

Rules Interpretations	74
2009 IWSF/AWSA Rules Differences	76
Officials Development Program Disciplinary Procedures	80
Tow Line Dimensions	82
Official Slalom Course	83
Slalom Entrance Gate Judgment Right Hand Gate Buoy	84
Slalom Scoring Diagram	85
Tow-Pylon Specifications Diagram	85
Official Jump Course Diagram	86
Ramp Setting Chart	87
AWSA Computer Benchmark for Jump Meter Set-up	88
AWSA Computer Benchmark for Jump Distance Calculations	89
Official Trick Course	90
Trick Speed Calibration Times	90
Trick Descriptions and Point Values	91
Speed Control Parameter Adjustment Chart	92
Jumping Event Timing Tolerance Table	93
Slalom Timing Chart – Standard Tolerance ABT Chart	94
Slalom Timing Chart – Wide Tolerance ABT Chart	95
Rules Jurisdiction Chart	96
Tournament Classification Requirements	Cover

RULE 1 - GENERAL

1.01 Application

The rules set forth here govern all sanctioned tournaments. Except as noted in Rule 1.06, no deviations are permitted from these rules for National Tournaments. For all other sanctioned tournaments, certain deviations are permitted. The exceptions are listed in the section of the rules to which they apply.

Whenever the masculine is used, the same shall be construed as meaning the feminine where the context so requires.

Class R and L events will run under AWSA administrative and sanctioning rules and must also meet the IWSF rules governing the conduct of the Slalom, Tricks, and Jumping events.

Contact USA Water Ski for additional variations permissible for Class N tournaments.

1.02 Tournament Classification (Also see Interpretations)

Sanctioned tournaments shall be designated: Closed (limited to residents within a certain locality or to certain classes or groups of skiers except as limited by Rule 3.01); Open; or Collegiate (National Collegiate Water Ski Association). All tournaments are further classified as Record Capability tournaments (Class R, L and E) in which World or National Records may be set; Class C - Standard local tournaments in which all Ranking List Performances other than Open may be earned; Class I - Local tournaments which for some reason do not meet the requirements of a Class C tournament; or Class N or F - Novice or Fun tournaments, primarily for beginning skiers, which allow wide variations from the requirements of the other classifications

Tournament classifications may be combined. For example, a Class R tournament may be run in conjunction with a Class C (or other).

A skier may not ski in more than one class in the same event in the same round at one tournament and may not ski more than three rounds in an event at a tournament. (See Rule 1.09 and Rule 13)

1.03 Sponsor Qualifications

All tournaments shall have at least one USA Water Ski-affiliated club as one of the sponsors. In order to sponsor a tournament, one or more of the sponsoring affiliated clubs shall meet the following qualifications:

Class R, L, and E Tournaments: An active sponsor of a sanctioned tournament held during or since the prior two calendar years. In addition, the Chief Judge of that tournament must certify that no serious deficiencies on the part of the sponsor existed, and that he would recommend sanction be granted for a Record Capability tournament. When a tournament is sanctioned as Record Capability, the special requirements of Rule 15 apply in addition to all others.

Regional or National Tournaments: Qualifications for hosting a Regionals or Nationals are the same as those for a Record Capability tournament.

Class C Tournaments: An active sponsor of a water ski tournament, sanctioned or unsanctioned, held during or since the prior two calendar years. In addition, the Chief Judge of that tournament must certify that it was run basically according to AWSA Rules, and that in his opinion the sponsor could produce a satisfactory tournament.

Class I, N, or F Tournaments: No experience qualifications are necessary.

1.04 Executive Vice President Approval

The approval of the Regional Executive Vice President (EVP) shall be required for all tournament classifications except Class F.

1.05 Regional and National Dates

Tournaments are held on an annual basis. The Regional Tournaments shall be held to conclude on a weekend, *one* to six weeks prior to the National Tournament, which shall be held during the second or third full week in August.

1.06 Exceptions to the Rules

Where compliance with the rules is infeasible, the Chief Judge shall, with the approval of a majority of the Appointed Judges, make the necessary change, inform each contestant, and send a report to the Rules Committee. Where the rules are definite and feasible, a vote of the judges to decide whether to enforce any provision is prohibited.

1.07 Interpretation of the Rules

Questions of interpretations of the rules should be referred to the Chairman of the Rules Committee when possible. In the interest of expediency, the Chairman may give his own interpretation, which shall be binding until the committee has been polled. This shall serve, however, only as a temporary interpretation until the Chairman refers the question to the entire committee for a vote in the normal fashion. Such a poll shall take place as promptly and in the most practical manner possible. Otherwise, the interpretation shall be made by a majority vote of the Appointed Judges, and the Chief Judge shall make a report to the Rules Committee concerning the question.

1.08 Amendments to the Rules

The rules may be amended at any time by the Board of Directors, on its own initiative or at the recommendation of the Rules Committee. Until such time as a new edition of the rules is published, the current rules, as amended by the Board, remain in effect. An individual may submit to the Rules Committee, prior to August 31, proposed rule changes, including new tricks, to be evaluated for the next year's rules.

1.09 Tournament Limitations

Tournaments shall be sanctioned for a period of not more than six consecutive days, except where an official postponement is necessary for reasons of safety. Except for the Nationals, U.S. Open, and Team Trials, a tournament site or sponsor shall be limited to a single tournament per day and not more than three rounds per tournament unless subsequent rounds after the third round are elimination based. See Rule 13.01(a).

1.10 Rule Change Authorization

Rule changes may be authorized for a particular tournament as follows:

- (a) At the request of the Rules Committee, for the purpose of trying out new provisions under consideration by the committee, and with the approval of a majority of the Appointed Judges for the tournament; or
- (b) At the request of the sponsoring affiliated club, and with the approval of a majority of the Appointed Judges, to conform with unusual situations, provided that such requests shall be presented to the Chairman of the Rules Committee at least three weeks in advance of the tournament date; and he shall give his decision at least one week in advance of the tournament date; or
- (c) At the request of the sponsoring affiliated club, for purposes of experimentation, promotion of spectator appeal, or other reasons, provided that such requests shall be presented with the request for sanction, and in any event at least six weeks in advance of the tournament, to the Rules Committee, which shall approve, amend, or deny the request, and shall give its decision at least one week in advance of the tournament date.

NOTE: It is the intention of the Rules Committee that the provisions for rule changes shall be used sparingly and only in the case of real merit. Tournaments falling under Rule 1.10(a) or (c) are designated by the notation "X" in addition to the classification R, L, E, C, I or N (e.g., Class RX).

1.12 Tolerances

In any activity involving the performance of an official where a tolerance is involved, it is the official's responsibility to be as close as possible to the actual specification. All tolerances are to allow for human error and the use of tolerances by Officials to improve skier performance will not be tolerated.

1.13 Tournament Reporting

All tournament scorebooks and boat timing data from USA WS sanctioned tournaments class C and above, **and scores from IWSF sanctioned international competitions to which USA Water Ski sends official team delegations**, shall be submitted for inclusion in the USA WS National Ranking List. The list will rank skiers based on the average of their top three tournament scores in slalom, tricks, jumping and overall unless a higher score is calculated using less than three tournaments and applying the appropriate penalty (see details below). For tournaments having multiple rounds only the best single round score will be taken for that tournament. A skier having fewer than three tournament scores will have penalties applied to the average of the scores they do have, in the respective classes reported, and based on the table below:

	<u>Penalty</u>
One Class C Score	10%
One Class E or above Score	5%
Two Class C Scores	5%
One Class E Score AND one Class C Score	2.5%

If the skier has two or more scores, then the Ranking List Score will be the highest of the following possibilities:

- i. The best single score with penalty for that one score according to the chart above;
- ii. The average of the best two scores with penalty for those two scores according to the chart above;
- iii. The average of the best three scores with no penalty.

(See Rule 3.06 for limitations on scores below a class C)

1.14 Tournament Sanction Review

Subsequent to the completion of a tournament, if information regarding the conduct of the event surfaces, or the Chief Judge reports that situations were encountered at the tournament, which are in violation of these rules (or rules under which the tournament was to be conducted), then the affected scores, events or the entire competition may be withheld from the ranking lists. The intention of this rule is to assure that appropriate standards of conduct are maintained at tournaments and to assure that only those performances conducted to the appropriate standards are included in ranking lists.

The procedure may be initiated by the Chief Judge of the tournament, the President of AWSA, the applicable Regional EVP, the Board of Directors of AWSA, the Chairman of the AWSA Technical Committee or the Chairman of the AWSA Rules Committee. Upon such request being initiated, both the Technical Committee and the Rules Committee will review the matter and with no less than two-thirds agreement of the members of the respective committees make a recommenda-

tion to the President of AWSA who will then proceed in accordance with AWSA Bylaws.

RULE 2 - TOURNAMENT EVENTS, ENTRY, REGISTRATION, ORDER OF CONTESTANTS

2.01 Events

The events in a tournament are Jumping, Slalom, and Tricks, with a champion and succeeding places determined in each event based on highest scores. Except for the Boys 1 and Girls 1 divisions, which do not include the Jumping event, National and Regional Tournaments must include all three events. The events to be scheduled at other sanctioned tournaments shall be determined by the sponsoring affiliated club and shall be listed in the tournament announcement.

2.02 Schedule of Events

A schedule showing the order of the events and divisions, the date on which they will occur and the starting hour for competition shall be published and made available upon request no later than two weeks prior to the start of the tournament. A schedule of starting times for individual events, if shown, shall be for the guidance of the contestants only, and any deviation from the schedule shall not constitute a change.

2.03 Schedule Changes

Changes in the schedule during the tournament shall be made only for weather, water conditions, safety or a similar reason, and not for the convenience of any skier. A majority of the Appointed Judges must approve the change, and all affected contestants or their representatives shall be notified. Although schedule changes are discouraged, the judges should not hesitate to make adjustments required for safety.

2.04 Entry

- (a) Nationals: All entries for the National Tournament (accompanied by the required entry fees) should be received by USA Water Ski Headquarters by 5 p.m. on Tuesday preceding the week of the Nationals. Late entries shall be accepted, provided that the contestant pay an additional entry fee established by the Board of Directors, per 24-hour period or portion thereof, after the 5 p.m. deadline. Late entries may be received at USA Water Ski Headquarters until noon of the Friday preceding the Nationals, or handed to the Chief Registrar at the National Tournament site until the close of registration the day before the scheduled start of the skier's event. The entry must only be on the Official National Tournament Entry Form. No other form will be accepted. It is recommended that entry forms be accompanied by proof of qualification.
- (b) Other Tournaments: Before the start of all tournaments, except the Nationals, the entry list shall be closed. Entries later than those noted may be allowed at the option of the sponsoring affiliated club. However, no entries shall be accepted later than ten minutes before the event is expected to begin.

2.05 Registration

- (a) Nationals: All contestants must register for the National Tournament, either in person, by mail or fax, or through a representative, providing all required proof of qualification and fees no later than one-half hour before the scheduled start of the contestant's first event. On-site registration must occur within the allowable hours as listed on the entry form and in *The Water Skier* magazine.
- (b) Other Tournaments: All contestants must register for the tournament, either in person, by mail or fax, or through a representative, providing all required proof of qualification and paying the entry fee. In all cases, registration must occur within the allowable hours as listed on the tournament announcement or at registration. No skier may complete his registration later than ten minutes before the contestant's first event is expected to begin.
- (c) In the event registration is done by mail or fax, the contestant assumes all responsibility for assuring that all proof of qualification and entry fees have been received and recorded by the Registrar.

2.06 Order of Contestants

- (a) Nationals: For the National Tournament, entry shall be closed as noted in Rule 2.04(a), and the order of contestants in each event shall be determined and posted by a Seeding Committee composed of one member from each Region, appointed by the AWSA President. The committee shall rank the contestants in each event according to ability, with the highest seeded skier skiing last. The committee shall be guided by performances during the year preceding the Nationals, and other factors at its discretion, and its decisions shall be final. No change in this order is permitted without the authorization of the Seeding Committee, except that a contestant may withdraw his name, in person or by proxy, before the event starts.
- (b) Other Tournaments: The order of contestants shall be made by random draw or shall be seeded before the start of the tournament. The Chief Judge shall designate the order of late entries pertaining to the manner in which they will be added to the order of contestants.

Except at Regional or National Tournaments, in the interest of expediency, a change in the order of contestants may be allowed by a majority decision of the Appointed Judges. Such a change is to occur prior to the start of the event.

- (c) For any division in which skiers request a lower ramp height, these skiers shall be grouped together and, at seeded tournaments, shall ski prior to those using the standard ramp height for that division.

RULE 3 - DIVISIONS OF COMPETITION AND PERFORMANCE RATINGS

3.01 Amateur and Professional Status

There shall be no distinction between amateurs and professionals.

3.02 Age Divisions

- (a) Competition for the three major events shall be separated into the following divisions as determined by the contestant's age. The "ski year" shall begin on the day after the conclusion of the Nationals, and shall end on the final day of the following Nationals. The contestant's age on December 31 of the ski year shall determine his division for the entire ski year. For example, if a skier's birthday within the "ski year" could result in an age division change and his birthday is between the day after the conclusion of Nationals and December 31 inclusive of that "ski year", he will ski in the older division, beginning the day after Nationals. Otherwise, he will remain in the younger division for one more season concluding with the end of the following Nationals.

<i>Division</i>	Age
Boys 1/Girls 1	9 years and under
Boys 2/Girls 2	13 years and under
Boys 3/Girls 3	17 years and under
Men 1/Women 1	18 - 24 years inclusive
Men 2/Women 2	25 - 34 years inclusive
Men 3/Women 3	35 - 44 years inclusive
Men 4/Women 4	45 - 52 years inclusive
Men 5/Women 5	53 - 59 years inclusive
Men 6/Women 6	60 - 64 years inclusive
Men 7/Women 7	65 - 69 years inclusive
Men 8/Women 8	70 - 74 years inclusive
Men 9/Women 9	75 - 79 years inclusive
Men 10/Women 10	80 - 84 years inclusive
Men 11/Women 11	85 and over
Open Men/Open Women	any age
Masters <i>Men</i>	35 and over

For Boys 1/Girls 1, only the Slalom and Tricks events may be scheduled, and overall scores will be determined from these two events. Entry in these divisions is optional. Any competitor age nine or under may enter any event as Boys 2 or Girls 2 (including Jumping), and may be eligible for overall in that division if he skis all three events in that division.

For Boys 1 & 2/Girls 1 & 2, entry in these divisions is optional. Any competitor age seventeen or under may enter any event as Boys 3 or Girls 3 (including Jumping), and may be eligible for overall in that division if he skis all three events in that division.

As to qualification for Open Men, Open Women and Masters **Men** divisions, see Rule 3.03.

- (b) At the option of the sponsoring affiliated club, one or more of the age divisions listed may be consolidated and/or divided into two or more groups, except as limited by Rule 3.01. This shall be noted in the tournament announcement.
- (c) A foreign skier's division may be listed, which would allow a foreign skier to ski under the same conditions as he skis under in his home federation. It is up to the skier to provide proof of membership and conditions. This would be a separate division, and competitors therein would not compete with USA Water Ski members for placement.
- (d) Except at Regionals and Nationals, skiers, upon proof of eligibility to try out in an event for any U.S. National Team, may be allowed to compete in that event under IWSF Rules and conditions. The results and conditions must be so noted in the scorebook and these skiers will not compete for placement when conditions are advantageous.

3.03 Open Division and Masters *Men* Competition

For entry into the Open or Masters **Men** divisions, performance and exceptional performance standards, as listed on the Official AWSA Water Ski Athlete Performance Qualifications sheet, must have been equaled or exceeded once at any National, Regional, or Record Capability tournament. For Masters **Men**, performances may occur at two Class C tournaments. The performance(s) must have taken place within the last 15 months for Open Divisions or within the last 12 months for Masters **Men** Division.

Entry into the Open or Masters **Men** divisions is optional. A skier entering one or two events in the Open division must qualify by Open qualification performance standards in each event. A skier entering three events, for overall placement, must qualify with one Open performance (as described above) ***and an overall score equaling or exceeding the Open division's overall rating as shown on the current AWSA Rankings Chart with the overall score calculated using the actual performances and the Open division's NOPS table.*** A skier skiing in one or more events in the Open division but not qualified for, or opting not to ski ***in the Open Division*** in the remaining event(s) may ski in ***their*** age ***Division*** (Rule 3.02).

3.04 Scheduling of Divisions

National and Regional Tournaments must schedule all of the above divisions.

Other sanctioned tournaments may schedule any or all divisions. The divisions to be scheduled at such tournaments, and whether or not skiers in excluded divisions will be allowed to ski with a scheduled division, shall be determined by the affiliated club sponsoring the tournament, and noted in the tournament announcement.

3.05 Scheduled Division Events

A scheduled division event shall be held as long as one skier is entered and registered.

3.06 Performance Ratings

Within each age division, each skier is ranked in each event and overall. The ability levels are 3 through 8 with 8 being the highest level. The ranking list is continually updated.

Scores for inclusion in the ranking list may be obtained in any sanctioned tournament, in any of the first three rounds (see Rule 1.02); exceptions include certain instances in elimination based competitions (see 13.02). A class N and F score may be included in the Ranking calculations if it does not exceed the Level 5 Cut Off Average from the previous Ski Year Rankings. Those class N or F scores which "exceed" the Level 5 Cut Off Average from the previous Ski Year Rankings, may be included but the score will be reduced to equal the Level 5 Cut Off Average for the purposes of inclusion in the Rankings calculations.

Scores for inclusion in the ranking list cannot be obtained in a run-off of a tie.

Performances accomplished at a multi-round tournament shall be credited as one tournament only.

RULE 4 - TOURNAMENT QUALIFICATION REQUIREMENTS

4.01 General Qualifications

- (a) Event Qualification: A skier must be qualified in each event he enters.
- (b) Membership: An entrant in a sanctioned tournament must be a USA Water Ski member with current dues paid. Each skier must be an Active member for Class C and higher tournaments. Guest membership is the minimum requirement for all other tournament classifications. This requirement shall be considered satisfied if the skier pays his dues to the tournament committee before competing, ***and completes all required USA Water Ski application and membership documents.*** A member of a national water ski association affiliated with the IWSF shall not be required to join USA Water Ski to enter sanctioned tournaments, if his association grants similar privileges to USA Water Ski members. However, he must be covered by USA Water Ski's insurance policy.
- (c) Tournament Qualification: For tournament qualification, the following are valid:
 - (1) Water Ski Athlete Performance Record card (signed by the required officials). Performance records issued by other IWSF-affiliated Federations are acceptable equivalents.

- (2) Record of performance in official scorebooks of AWSA-sanctioned tournaments.
- (3) Current Ranking List Average as listed on the National Ranking List on the USA Water Ski website.

4.02 National Tournament Qualifications

General: A contestant in the National Tournament must have competed in the corresponding event at his Regional Tournament (see Rules 4.03 and 4.06) during the same year. To have competed in an event at a Regional Tournament means to have attained skiing position in each event as defined in Rule 8.07. In addition, a contestant must qualify under Rules 4.02(a), 4.02(b), or 4.02(c) below and must be a U.S. Citizen. However, a competitor who skis in international competition for another federation shall not be eligible for placement for two years following the international competition. Any skier competing in international competitions representing Guatemala, Costa Rica, Puerto Rico, Dominican Republic, Cuba, Ecuador, Bolivia, Panama, Paraguay, Uruguay and Venezuela with dual US citizenship would be exempt from rule 4.02(a) and 4.03(a) for the period of January 1, 2009 until December 31, 2009. A skier who enters the Open division at the Nationals in any event is not required to ski in his Regional Tournament.

If the Appointed Judges at a Regional Tournament disqualify a skier for unsportsmanlike conduct, the skier will not have met the requirement of skiing in the Regionals and thus would not be allowed to ski in the Nationals.

- (a) Placement Qualifications: a skier may qualify for that event or overall in the National Tournament by placing 1st through 5th at the current year's Regionals or previous year's Nationals.

Placement includes only those scoring above zero. The above qualifications from past National placements apply even if a skier changes divisions.

If more than one round of competition is held at a Regional Tournament, the scoring must still result in a single set of qualifiers for the National Tournament.

- (b) Ranking List Qualifications: a skier may qualify for the National Tournament in any event or overall by being ranked Level 8 at the Cut Off Date, which is 3:00 a.m. Eastern Time on the Thursday three weeks prior to the Thursday immediately before the start of the National Tournament. The rankings average of the last ranked skier in level 8 at that time will be considered the Level 8 Cut Off Average for that event and division (See Ranking List Section of Website for specific details). A skier may also qualify for Nationals after the Cut Off Date by increasing his Ranking List Average above the Level 8 Cut Off Average for his respective event and division between the Cut Off Date and Nationals; or by attaining a score equal to or greater than the Level 8 Cut Off Average for his respective event and division at the Regional Tour-

nament or at any class E, L or R event between the Cut Off Date and the first day of Nationals.

- (c) Standards for Changing Divisions: The National Ranking List will include scores achieved in the prior division on a rolling 12 month basis in the new age division provided the performance conditions (speed and/or ramp height) of the new division are identical.

4.03 Regional Tournament Qualifications

- (a) General: Each Region shall determine the required qualifications for its own Regional Tournament.

In any year, a skier shall be qualified to enter only one Regional Tournament for placement. A skier shall ski for placement in the Region where he does more than half of his skiing, including tournaments and practice, during the ten weeks prior to the Regional Tournament. The amount of skiing done in a Region applies to actual time on the water. A skier has the option to return to his Region of legal residence to ski for placement.

If this rule is clearly inequitable, the Regional Executive Vice Presidents of the affected Regions may correct the situation at the request of the skier prior to July 16th immediately preceding Nationals. EVP's from the Regions involved must be in agreement.

If the skier has not done more than half his skiing in the ten-week period in any single Region, he shall ski in the Region in which he has skied most. If a skier is in doubt as to the Region in which he is qualified to ski, he shall present all the facts to the Regional Executive Vice President in the Region in which he has legal residence prior to July 16th immediately preceding Nationals and the Regional Executive Vice President's decision shall be final. If there is any question regarding a particular skier's Region, the Executive Vice President is required to rule based on the legal residence of the skier. This may be accomplished with a telephone directory or telephone call to the town in question. A skier skiing "out of Region", based on the ten-week rule, may thereby satisfy the requirement to compete in a Regional Tournament to qualify for the National Tournament (Rule 4.02(a)), and may ski for ratings only. He may not ski for Regional placement.

All entrants in a Regional Tournament shall be U.S. citizens, unless the Region determines to allow non-US citizens (or resident aliens) to participate, but not for placement. However, a competitor who skis in international competition for another federation shall not be eligible for placement for two years following the international competition.

- (b) Excuses: A skier who is unable to compete in a Regional Tournament may be excused from the Regional Tournament provision of Rule 4.02(a) for the following reasons:

- (1) AWSA Representatives: An individual, officially selected by the AWSA to represent the Association at an international competition on the same dates as his Regional Tournament, may be excused. This may be extended to include not only athletes but judges, scorers, drivers, delegates, and other officials.

In the case of minors, this may also be extended to include parents or legal guardians of same.

- (2) Other Excuses: The EVP may excuse a skier from this requirement if the skier provides proof, at least 48 hours prior to the start of the Regional Tournament, that he is confined to a full-facility hospital; is on extended military service; is on jury duty; is involved in an immediate family tragedy; or has suffered an injury or illness that precludes him from participating. The proof provided to the EVP must be sufficient to allow the EVP to make a fair and objective determination regarding the skier's ability to ski at the Regional Tournament. If the skier does not provide sufficient documentation (e.g., hospital admittance form, jury duty notice, etc.) within the stated time frame, the skier must appear before the EVP at the Regional Tournament, prior to the skier's scheduled event, at which time the EVP will make a determination as to the skier's ability to ski in the tournament. The EVP may excuse a skier for reasons other than those listed above, and with less than 48 hours notice, under extraordinary circumstances. Any skier misrepresenting his situation to the EVP shall be precluded from skiing in the National Tournament for the current year.

4.04 U.S. Open Qualifications

The U.S. Open may be entered in any event by any skier meeting performance standards set by the AWSA Board of Directors for that event and providing proof of membership in a federation recognized by the IWSF. For detailed information on entry requirements, contact USA Water Ski Headquarters.

4.05 Other Tournament Qualifications

The sponsoring affiliated club shall determine the required qualification standards for its tournament.

4.06 Event and Division Limitations

The division that a skier competes in at the Regional Tournament in any event shall be the division that said skier competes in, in the same event, at the National Tournament except that a skier not currently qualified may qualify for the Open or Masters 55k division of the Nationals by meeting the requirements for that division at or after the Regional Tournament.

RULE 5 - OVERALL AND TEAM COMPETITION

5.01 Overall Qualification

To be considered for overall standings, a contestant must be qualified for, entered in, and attain skiing position in all three events, except Boys 1/Girls 1 where overall is based on only two events and for divisions 8 and up the skier may use scores from ANY two events or all three events towards the overall title.

5.02 Overall Placement

Places in the overall championship shall be determined by adding each contestant's overall points in the three events (except Boys 1/Girls 1, as noted above).

Each division's overall shall be limited to those skiers entering only that division's events.

5.03 Overall Scoring

- (a) In scoring for overall positions within each division, each competitor shall receive a NOPS (Normalized Overall Performance Score) for each event, calculated from his performance in that event, relative to standards for that specific division and event, using a smooth curved mathematical fit to those standards.
 1. The standards for each division and event shall be set annually by the Skier's Qualification Committee, based on the distribution of scores for the skiers in that particular division and event, over the preceding 12 month period.
 2. The smooth curved function for each division and event shall be formulated such that:
 - a. In slalom and tricks, a raw event score of zero will produce a NOPS score of zero.
 - b. In jumping, a raw event score of less than 15% of the National Record Jump Score for that division will produce a NOPS score of zero.
 - c. A raw event score that equals the Median (50th percentile ranking) score for that division and event shall receive a NOPS score of approximately 500 points.
 - d. A raw event score that equals the National Record score for that division and event shall receive a NOPS score of approximately 1500 points.
 - e. The smooth curved function for each division and event shall be based on the ratio of the skier's raw performance score in that division and event, divided by the

standard score for that division and event, with that ratio raised to a specified power. The specified power values for each division and event shall be computed to best fit provisions a-d above.

3. The Skier's Qualification Committee shall annually publish a table of the NOPS standards, and the associated computational formulas and power factors, for each division and event for the next ski year.
- (b) 1,000 Point Overall Standard: For other than the National and Regional Tournaments, the following overall scoring may be used. At the option of the sponsoring affiliated club, the highest scoring three-event skier (or the highest scoring team-affiliated skier, if the tournament includes team competition) in each event shall be awarded 1,000 points for overall. If this option is used, it shall be noted in the tournament announcement. Each remaining contestant in the Slalom and Tricks events shall receive points in the proportion that his score bears to the winner's score. For example, a trick skier receiving a total of 1,130 points compared with the winner's 2,560 would be entitled to $(1,130/2,560) \times 1,000$, or 441 points toward overall. Each remaining contestant in the Jumping event shall receive points in the proportion that the square of his score bears to the square of the winner's score. For example, a jumper receiving a total of 130 points compared with the winner's 150 would be entitled to $[(130 \times 130)/(150 \times 150)] \times 1,000$, or 751 points toward overall.

All three performances for an overall score must be performed in the same round of a multi-round tournament (i.e., first time skied per event = Round #1, second time skied per event = Round #2, etc.).

Run-offs of ties are used solely to determine placement in an event and are not used for any other purpose such as scoring overall, setting records or inclusion in ranking list.

5.04 Team Scoring

- (a) In team competition, the overall points of each competing team member shall be totaled to obtain the team score. Alternatively, if the teams are not of approximately equal size, the number of overall scores credited to each team in each event may be limited (with the highest such scores being counted), or overall points earned below a specified placement in each event may be excluded.
- (b) Any sanctioned tournament may include team competition. The tournament announcement must specify the team membership qualifications and, if applicable, any score eligibility limitations to be imposed in accordance with Rule 5.04(a).
- (c) In the National Tournament, the team championship shall be awarded to the regional team scoring the most team points. Each regional team shall be credited with the highest seven NOPS scores produced by any of its skiers in

each of the three events. A skier in the National Tournament must ski for the region in which he qualified under Rule 4.03.

RULE 6 - OFFICIALS

6.01 National Tournament

- (a) The Chief Judge, Assistant Chief Judges, and the Qualifications Judge shall be three-event Senior Judges appointed by the AWSA President.
- (b) Other Appointed Judges (two from each region) shall be three-event Senior Judges appointed by the Regional Executive Vice President with approval of the Regional Council.
- (c) Event judges shall be chosen by the Chief Judge from among the Appointed Judges. When the Appointed Judges are not available as event judges, the Chief Judge may choose other Senior or Regular Judges as event judges. In all events, the majority of the event judges must be Senior Judges.
- (d) The Chief Boat Driver shall be a three-event Senior Driver appointed by the AWSA President.
- (e) Boat Drivers (two from each region) shall be three-event Senior Boat Drivers appointed by the Regional Executive Vice President with the approval of the Regional Council. Additional drivers shall be chosen by the AWSA President at his discretion from alternate drivers proposed by the Executive Vice Presidents.
- (f) The Chief Scorer shall be a three-event Senior Scorer appointed by the AWSA President. Assistant Chief Scorers with a three-event Senior Scorer's rating may also be appointed.
- (g) Scorers (two from each Region) shall be three-event Senior Scorers appointed by the Regional Executive Vice President with the approval of the Regional Council. Event scorers shall be chosen by the Chief Scorer from the Appointed Scorers. When the Appointed Scorers are not available as event scorers, the Chief Scorer may choose other Senior Scorers or Regular Scorers as event scorers, with the approval of the Chief Judge.
- (h) The Chief Safety Director shall be a National Safety Director appointed by the AWSA President. Assistant Chief Safety Directors with a National or Regional Safety Director rating may be appointed by the AWSA President. Other safety personnel, with a minimum rating of State Safety Director, may be chosen by the Chief Safety Director.
- (i) The Chief Technical Controller shall be appointed by the AWSA President. Assistant Chief Technical Controllers may also be appointed.

6.02 Regional Tournaments

- (a) The Chief Judge shall be a three-event Senior Judge appointed by the Regional Executive Vice President with approval of the Regional Council. Assistant Chief Judges with a three-event Senior or Regular Judge rating may also be appointed.
- (b) Five three-event Appointed Judges (Senior or Regular) shall be appointed by the Regional Executive Vice President with the approval of the Regional Council.
- (c) Event judges shall be chosen by the Chief Judge from among the Appointed Judges or other Senior or Regular Judges in attendance at the tournament.
- (d) The Chief Boat Driver shall be a three-event Senior Driver appointed by the Regional Executive Vice President with the approval of the Regional Council. Assistants with three-event Senior or Regular Driver's ratings may also be appointed. Event Drivers shall be chosen by the Chief Boat Driver from the Appointed Drivers, or other Senior or Regular Drivers, subject to the approval of the Chief Judge.
- (e) The Chief Scorer shall be a three-event Senior Scorer appointed by the Regional Executive Vice President with the approval of the Regional Council. Assistant Chief Scorers with a three-event Senior or Regular Scorer's rating may also be appointed. Other scorers, with a Senior or Regular Scorer's rating, may be selected by the Chief Scorer from those in attendance at the tournament, with the approval of the Chief Judge. Where there is a shortage of Regular and Senior Scorers, an Assistant Scorer may work under the supervision of a Senior or Regular Scorer.
- (f) The Chief Safety Director shall be a Regional Safety Director appointed by the Regional Executive Vice President with the approval of the Regional Council. Assistant Chief Safety Directors, with a minimum rating of Regional Safety Director, may also be appointed. Other safety personnel, with a minimum rating of State Safety Director, may be chosen by the Chief Safety Director.
- (g) The Chief Technical Controller shall be appointed by the Regional Executive Vice President with the approval of the Regional Council. Assistant Chief Technical Controllers may also be appointed.

6.03 Other Tournaments

- (a) A Chief Judge and at least two other judges (all Senior or Regular in the events being held) shall be appointed by the sponsoring affiliated club with the approval of the Regional Executive Vice President. An Assistant Chief Judge, holding not less than an Assistant Judge's rating, may also be appointed.
- (b) The event judges shall be chosen by the Chief Judge from among the Appointed Judges or other judges in attendance at the tournament holding not

less than an Assistant Judge's rating or a judge's rating from a federation affiliated with the IWSF. It is recommended that, insofar as practical, the Chief Judge select event judges from among the most capable judges available.

- (c) A Chief Boat Driver (with Senior or Regular rating) shall, and the necessary assistants may, be appointed by the sponsoring club with the approval of the Regional Executive Vice President.

Event drivers shall be chosen by the Chief Boat Driver from the Appointed Drivers, or other Senior, Regular, or Assistant Drivers available, subject to the approval of the Chief Judge. It is recommended that the Chief Boat Driver select event drivers from the most capable drivers available.

In areas where no Senior or Regular Drivers are available, the sponsoring club of a Class C tournament or below may appoint Assistant Drivers as event drivers (with the approval of the Regional Executive Vice President), in which case the Chief Judge will assume the duties of the Chief Boat Driver.

- (d) A Chief Scorer (with Senior or Regular rating) shall be appointed by the sponsoring affiliated club with the approval of the Regional Executive Vice President.

In areas where no Senior or Regular Scorers are available, the sponsoring club of a Class C tournament may appoint an Assistant Scorer as Chief Scorer (with the approval of the Regional Executive Vice President), under the supervision of the Chief Judge.

Event Scorers shall be selected by the Chief Scorer from other scorers in attendance at the tournament subject to the approval of the Chief Judge.

- (e) At Class C tournaments, the chief officials shall preferably be separate officials.
- (f) A Class I tournament may be limited to a Chief Judge (Senior or Regular) and two other judges (Senior, Regular, or Assistant), a Chief Driver (Senior, Regular, or Assistant), a Chief Scorer (Senior, Regular, or Assistant) and a Safety Director (National, Regional, or State) appointed by the sponsoring affiliated club, with the approval of the Regional Executive Vice President.

A Class N tournament may be limited to an Assistant Judge, an Assistant Driver, and a State Safety Director.

A Class F (Fun) tournament may be limited to a Safety Coordinator and a Trained Driver.

- (g) A Chief Safety Director, with a minimum rating of State Safety Director, shall be appointed by the sponsoring affiliated club with the approval of the Regional Executive Vice President. An Assistant Chief Safety Director may also be appointed. The Assistant Chief Safety Director and other safety personnel may be aspiring State Safety Directors.

- (h) For Record Capability tournaments, a Technical Controller shall be appointed by the sponsoring affiliated club with the approval of the Regional Executive Vice President. For all computer operations involving video jump distance measurement or frame count trick timing, a rated Technical Controller shall be considered fully qualified as an appropriately rated judge.

6.04 Secondary Personnel

Personnel to fill secondary positions shall be selected by the Chief Judge from other rated judges or USA Water Ski insured members who desire training in tournament work.

6.05 Disagreement

In any disagreement among judges, the majority rules, and all issues should be settled before the next contestant starts.

6.06 Inspection of Forms

The scoring of each judge shall be made available for inspection as soon as possible, but not later than the end of the tournament.

6.07 Separation of Judges

Judges shall be separated to ensure completely independent opinions. Where it is not feasible for judges to be separated, judges' positions shall be designated by the Chief Judge.

6.08 Changes in Scoring Forms (Also see Interpretations)

Any changes in scoring forms must be approved by the Chief Judge once the results of that event have been posted. A judge may not change his scoring form more than 30 minutes after the results of the event are posted.

6.09 Changing Officials

At the discretion of the Chief Judge, any or all officials may be changed during a large Slalom or Jumping event. The event may be divided into groups to accommodate officials changing, although no such group shall have fewer than 15 skiers. Under exceptional circumstances, the Chief Judge may change any official at any point during an event.

With the approval of the Appointed Judges, two boats and boat crews may be used in the same event in an alternating manner. *Alternating manner* shall mean the next available towboat will be used for each successive skier. See Rules 8.02(d), (e) and (f).

6.10 Defining "Judge"

The term "Judge" refers to an AWSA-rated Senior, Regular or Assistant Judge, IWSF Class 1, 2 or 3 Judge or any Pan American equivalent. Other federations' or

regions' judges' ratings are equated to those of AWSA for use in assigning tournament personnel as follows:

AWSA-rated Senior Judge - EAME Class 1/Canadian Levels 3 and 4
AWSA-rated Regular Judge - EAME Class 2/Canadian Level 2
AWSA-rated Assistant Judge - EAME Class 3/Canadian Levels 1

Note: EAME = Europe, Africa and Middle East

6.11 Judge/Scorer Emeritus (Also see Interpretations)

A Senior Judge Emeritus or Senior Scorer Emeritus may officiate in any tournament up to and including Class C and as an assistant judge in a Class E.

6.12 Multi-Round Tournaments

Officiating duties accomplished at a multi-round tournament shall be credited as one tournament only.

6.13 Chief and Appointed Officials

Chief and appointed officials for any tournament shall hold the required rating level for all events that are scheduled in that tournament, and these officials shall remain available on the site throughout the entire tournament.

RULE 7 - RERIDES, PROTESTS AND DISQUALIFICATION

7.01 Unfair Conditions (Also see Interpretations)

When unfair conditions or a malfunction of tournament committee-supplied equipment occurs, which, in the opinion of a majority of the event judges, adversely affects a contestant, he shall be granted the option of a reride only on the passes affected. In the case of a malfunction of committee-supplied equipment or if there should be fast slalom times, slow jump times, or short trick times, then, if such an optional reride is taken, the official score shall be the better of the reride score or the score obtained on the original adversely affected pass(es). In all other instances if the reride is taken, the result of the reride is the official score.

When a condition gives a contestant an unfair advantage, a reride is mandatory, and the result of that reride shall become the official score.

7.02 Reride Time Limits

A reride must be taken no later than five minutes after being granted, and may be taken immediately at the option of the contestant (see Rule 9.10 for Jumping rerides, Rule 10.10 for Slalom rerides, and Rule 11.10 for Tricks rerides). If the contestant elects to take a five-minute rest, the next contestant in order shall ski, and the reride shall be taken at the conclusion of the skier's run during which the five-minute rest period expires.

7.03 Requests for Rerides

A request for a reride may be initiated by a judge for the event before the next contestant starts or may be initiated, as soon as possible, by the contestant or his representative. In either case, the reride shall be decided upon before any further contestants start. If, in the opinion of the judges for the event, the request was not initiated as soon as possible after the contestant skied, the request shall be denied.

7.04 Protest Procedure

Protests shall be made to the Chief Judge and shall be considered by the Appointed Judges. Protests must be in writing, give the reason for the protest, be signed by the contestant, and be filed no later than 30 minutes after the results of the event are posted and the judges' scoring forms are available for inspection.

7.05 Protests

Protests shall be considered only for failure of the tournament committee or the officials to comply with these rules. No protest shall ever be considered on judgment decisions by the judges.

7.06 Corrected Scoring Errors (Also see Interpretations)

A correction of an error in the computation of scores shall not be considered a protest. Such correction shall be made upon the approval of the Chief Judge and the Chief Scorer, if requested within two hours after the results of the event are posted and the judges' scoring forms are available for inspection.

Correction of scores on the Ranking List can be made with the approval of the Chief Scorer and Chief Judge provided the error change was initiated within seven days of posting on the Ranking List. Such a change will not affect the official tournament results or placements. The revision will be made only on the ranking list after submitting the performances and placements as originally scored.

7.07 Disqualification

- (a) Not Ready to Ski: Any contestant who fails to be on immediate hand and in condition to ski when the boat is ready for the contestant shall be disqualified from the remainder of the event in that round. However, ***the Chief Judge or his designee***, may grant up to ***three*** additional minute for emergencies developing or discovered just prior to the contestant's turn to ski (e.g., ripped binding).
- (b) Unsportsmanlike Conduct: Any contestant (or his representative) or official whose conduct is deemed unsportsmanlike or whose conduct may cause discredit to USA Water Ski, either on or off the tournament site before, during, or after the tournament, may be disqualified from participation in the tournament by a two-

thirds majority vote of the Appointed Judges. The Chief Judge shall submit a report to the AWSA Board of Directors regarding any such disqualification.

- (c) Passing Between the Boat and Jump Ramp in the Jumping Event: See Rule 9.18.
- (d) Interference by Quick-Release Operator: See Rules 11.16(b) and 11.18.
- (e) Under the Influence of a Mind Altering Substance: Being under the influence of alcohol, drugs, or any other mind altering substance, or if his participation would be a danger to himself or others, subjects a competitor to disqualification procedures. Disqualification is by a two-thirds majority vote of the Appointed Judges.
- (i) Misrepresentation of Age or Ranking: Disqualification is by a two-thirds majority vote of the Appointed Judges.

RULE 8 - EQUIPMENT AND DEFINITIONS

8.01 Competition Area

The suggested tournament layout is shown in the Slalom, Jumping, and Tricks Diagrams contained in the Appendix. Courses' dimensions shall be as indicated. However, the layout of the competitive area may be varied to suit the tournament site. No buoys or markers other than those indicated by the official course diagrams are permitted within the competition area, except safety hazard or turning point markers, boat path alignment buoys, or video jump distance buoys. Any such additional buoys shall be distinguishable from tournament buoys and shall be pointed out to skiers at the start of the competition.

Dimensions and Tolerances: Metric dimensions, when given, are official. Accompanying notations stated in feet and inches or pounds are approximate and are provided as a convenience only. Tolerances on dimensions are to allow for uncontrollable site variations and human error only. See Rule 1.12

When courses overlap, buoys from the unused course that may cause confusion or a safety hazard shall be removed.

8.02 Boats

- (a) General: All tournaments, except Class F "Fun" tournaments, are required to use only AWSA-approved tournament towboats. Contact USA Water Ski Headquarters for approval requirements and details as set forth in the AWSA Towboat Manual.
- (b) Added Weight: It is the duty of the boat judge, in consultation with the driver, to supervise adding a suitable weight in any event to even out boat balance, wakes, spray, or handling. This weight shall not present a hazard to the boat occupants or potential harm to the boat interior.

For tricks, the skier may place a tournament-supplied weight of between 20-50 kg (44-110 pounds) in the boat (either on the floor by the feet of the release operator or behind the engine cover) with side to side positioning as decided by the skier or release operator.

- (c) Boat Availability: Any boat that is to be used in the tournament shall remain available until the end of the tournament unless released by the Chief Judge. Only designated persons may occupy official towboats during competition.
- (d) National and Regional Tournaments: The selection of boats and the assignment of boats to specific events in the National and the U.S. Open tournaments shall be made by USA Water Ski Headquarters. ***National Towboat selection shall occur no later than July 1st.*** For Regionals, USA Water Ski Headquarters shall make the selection of boats, and the assignment shall be made by the Chief Judge and the Chief Boat Driver. The same boat and driver shall be used by all contestants in each Slalom and Jumping event, except in an emergency situation such as where time is a factor and similar boats and drivers of similar abilities are available and the Appointed Judges, by majority vote, may elect to use two boats and drivers in the same event in an alternating manner. *Alternating manner* shall mean the next available towboat will be used. However, in Jumping and Slalom tie run-offs only one boat and driver shall be used. For the Tricks event, the skier may select a boat from any of the designated towboats.
- (e) Other Tournaments: At all other tournaments, the selection of towboats shall be established by the Chief Boat Driver with the approval of the Chief Judge from the available towboats. The same boat and driver shall be used by all contestants in each Slalom and Jumping event, except in cases where similar boats and drivers of similar abilities are available, in which case the Appointed Judges, by majority vote, may elect to use two boats and two drivers in the same event in an alternating manner. However, in Jumping and Slalom tie run-offs, only one boat and driver shall be used.

For Tricks, all types of boats furnished for the tournament will be made available by the tournament committee. Two teams of drivers and boat officials may be assigned to the Tricks event at the option of the Chief Judge.

- (f) Towboat Breakdown: When a towboat breakdown occurs, the Chief Driver with the concurrence of the Chief Judge may select a similar towboat to complete the event. For the purpose of towboat malfunction, "similar" shall mean an AWSA-approved tournament towboat of the same power and design (i.e., inboard, 351 c.i.). For Regionals, Nationals and Cash Prize tournaments, any substitute towboat shall be of the same model and manufacturer. However, when running dual boats, the event may be continued with one boat, or if substitution is necessary, the two boats continuing the event must be of the same model and manufacturer.

8.03 Skis

- (a) Maximum ski width shall not exceed 30% of the length.
- (b) Any type of fixed foot binding may be used.
- (c) Any type of fixed fins may be used.
- (d) No other devices are permitted, except that devices affixed to the ski intended to control or adjust the skiing characteristics of the ski are allowed as long as they are fixed, in that they do not move or change during actual skiing.
- (e) With all bindings, fins, etc. installed, the ski must float.
- (f) Skis in the Tricks event shall not have fins.

8.04 Tow Lines

The Tournament Committee shall furnish tow lines constructed as in 8.04(c) below with the lines and handles meeting the following specifications:

- (a) Weight per foot, maximum = 23 g/m (.250 oz.)
 Breaking Load, minimum = 817 kg (1,800 lbs.)
 Elongation at 115 kg (250 lbs.) tensile load, 2.6% ± 0.4%
 The gauge length shall be set at 5.5 kg (12 lbs.) tensile load

Optional: Junior Towlines for B1, G1 events only

***Weight per foot, maximum = 23g/m (.250 oz.)
 Breaking Load, minimum = 454 kg (1,000 lbs.)
 Elongation at 115 kg (250 lbs.) tensile load, 4.0% ± 0.5%
 The gauge length shall be set at 5.5 kg (12 lbs.) tensile load***

All measurements of tow lines shall be made under 20 kg (44 lbs.) tension for at least 30 seconds and shall be made between the following points, as applicable:

- (1) The centerline of that portion of the handle furthest from the attaching loop;
- (2) The inside surface of any attaching loop furthest from the handle;

Tow line measurements shall comply with the Tow Lines Dimension Chart in the Appendix.

- (b) Splices at the bridle and loop end of the line shall be 15 cm (6") long minimum, and secured with tucks before and/or after the splice, knotted to prevent slippage.
- (c) The tow lines must be made in two sections consisting of a single line 21.5 meters long (70' 6.5") and a handle section 1.5 meters long (4'11"). Two-piece lines must be provided by the Tournament Committee, and the 21.5-

meter section, which can be attached to the contestant's handle section by looping the lines together, must be made available. In addition, colored multi-section lines may be used if the Technical Committee has specifically approved their design and type.

- (d) The handle or handle assembly shall be made of 2.5 cm - 2.8 cm (1" to 1.25") outside diameter material with no sharp edges or projections, and it is recommended that it shall float. The attaching ropes must in all cases go completely through the handle twice and must be attached so there is no possibility of movement between the rope and handle when in use. The recommended minimum certified "permanent set load" of the handle, as measured with a six-inch straight edge across the handle, shall not exceed .039 cm (0.015") at any point along the handle at a load of 408 kg (900 lbs.), applied at any rate greater than or equal to 272 kg (600 lbs.) per minute. The test load shall be applied at two points 9 cm (3.5") apart at the center of the handle with the ends of the handle supported at the rope holes. The two load points shall each have a radius of .635 cm (0.25") and the end support may be any support which shall bear positively at the rope holes. A manufacturer may furnish a handle-bridle combination which may not necessarily have double entry at rope attachment, but such design must be approved by the Technical Committee following assurance of quality control through testing that shows all other requirements, including minimum loads, are complied with.
- (e) Class E, L and R events pulled with alternating ropes shall use lines of the same model and manufacturer.

8.05 Boat Speeds

All speeds are "speeds over the bottom"; compensate in all cases where a current exists. The boat path in all events is intended to be a straight line, run at a constant speed. Variation in speed during any pass may not exceed $\pm .8$ kph (.5 mph), except during the second segment in the jump course when using the optional faster second segment option. In the Slalom and Jumping events, the recorded times through the timing segments must also be within the applicable tolerances. (See Rules 9.06, 9.17, 10.06, 10.17, 11.06 and the Timing Tolerances Tables.)

8.06 A Fall

A fall in any event is when any one of the following occurs:

- (a) The skier loses possession of the tow line (except as noted in Rules 9.11, 10.11 and 11.11); or
- (b) The skier does not have at least one ski on one foot; or
- (c) The weight of the skier is not primarily supported by his ski or skis, and in addition the skier is unable ultimately to regain skiing position.

If the skier does not lose possession of the tow line, has at least one ski on at all times, and ultimately regains skiing position, there has been no fall.

8.07 Skiing Position

Skiing position is defined as that position in which all of the following exist:

- (a) The skier has possession of the tow line; and
- (b) The skier is riding forward or backward on the water with a ski or skis on his feet; and
- (c) The weight of the skier is supported by his ski or skis and the skier is ultimately able to regain control.

8.08 The Wake

In the application of rules where the wake plays a major role in the decision-making process, "the wake" is to be considered as the area of water disturbed by the passage of the towboat, lying at the rope's length between and inclusive of the outermost waves. The crest of the wave is the nominal boundary of the wake. With some waves there is a curl that identifies the crest, but if the wave is rounded, the crest is determined as the point where the wave takes a downturn to the outside of the wake.

8.09 Buoys

- (a) Buoys must have provisions for attaching anchor lines, and must be fastened by means of a tensioning device.
- (b) Boat guide buoys may be spherical, cylindrical, or bullet-shaped. Spherical buoys shall be 22 - 28 cm (8.75" to 11") in diameter (23 cm (9") recommended), and fastened so that they have 11 - 17 cm (4.375" to 6.75") of height out of the water (11.5 cm (4.5") recommended). Non-spherical types may have a cross-sectional area of 75 - 450 square cm (12 - 70 square inches), shall appear vertical, and shall be 15 - 30 cm (6 - 12") exposed above the water.

Boat path alignment gates where required in Slalom, shall consist of cylindrical buoys of a color contrasting to the official course buoys (green recommended) and shall be placed outside the official course at either end, at a distance of 55 meters beyond the entrance gates, and at the 1.15-meter width of the interior boat guide buoys.

- (c) Skier buoys shall be generally spherical in shape and 20 - 28 cm (7.8" to 11") in diameter (20 cm (7.8") recommended), and fastened so that they have 10 - 17 cm (3.9" to 6.75") of height out of the water (10 cm (3.9") recommended). They shall be of lightweight, pliable material with a smooth, exposed surface.

- (d) End gates in the slalom course shall be provided with an elastic device or equivalent which will allow the buoys to rise and fall under tension with the passage of the wakes. These end gate buoys shall be the same size as skier buoys and shall be fastened so that they have the same height out of water.
- (e) For colors and placements of buoys see Rules 9.16(d), 10.16(b) and the diagrams in the Appendix.

8.10 Speed Control

- (a) All tournaments Class C and above are required to use speed control.
- (b) The principal job of the speed control is to provide independence from the manual operator and to give speeds as close as possible to the ideal times.
- (c) The boat judge and driver shall jointly agree on the setting of the speed control and the allowed adjustments, with the goal of having the device produce ideal times for each pass. If agreement cannot be reached the Chief Judge, or his designee, shall make the decision.
- (d) A table showing the allowed ranges for all adjustable speed control parameters, and the circumstances under which each of these may be changed, and by whom, is provided in the Appendix.
- (e) If the speed control unit becomes inoperable and cannot be quickly repaired, and a replacement boat or unit is not available, the tournament shall be continued with manual driving with no other effect.
- (f) When the speed control cuts out or fails to operate properly or there is otherwise a deviation from normal operation (i.e., a malfunction), the skier is entitled to a reride for failure of tournament-supplied equipment. (See 7.01, 9.10 and 10.10(b)(4)) (See Rules Interpretations) If the time is out of tolerance due to a malfunction of tournament supplied equipment the skier may accept the highest score with a good time or receive an optional reride with a protected score equal to the highest score with a good time. (See rule 10.10(b)(4) and Interpretations)
- (g) Tournaments are only allowed to use speed control devices tested in conjunction with the towboats approved for use by the Towboat Committee. Approved towboats, including equipment as tested, are listed on the USA WS website under the Towboat section.
- (h) Software changes are permitted as approved by the Towboat Committee at any time during the season, except that no changes that affect skier pull will be permitted between July 1 and the conclusion of that year's National Tournament.

RULE 9 - JUMPING

9.01 General

Each contestant shall be allowed three passes through the jump course.

9.02 Jump Course

The jump course begins with the 180-meter cut-out buoy and ends with the 100-meter end-course buoys as shown in the Official Jump Course Diagram in the Appendix. Buoy specifications are presented in Rule 8.09.

9.03 Pass or Jump

- (a) A pass or jump shall be registered when a skier, in skiing position, passes the 180-meter buoy marking the beginning of the jump course (see Official Jump Course Diagram in Appendix), except when, in the opinion of the boat driver or boat judge, there is a hazard because of rough water, interference of another boat or other reasons. In this case the boat driver or boat judge shall hold up his hand and slow the boat a perceptible amount before the boat passes the ramp.
- (b) A pass shall also be registered if a skier falls within or outside the course, or if the reason for a handle throw is not acceptable to the judges (Rule 9.11).
- (c) A jump shall be scored when a skier passes over the ramp, lands, and skis away with a tight line in skiing position without falling. If a skier falls as a result of a jump, he loses that jump. If he shall purposely touch any part of the tow line other than the handle while in the air, he shall receive no score for that jump.
- (d) A pass is defined as the movement of the boat by and parallel to the ramp, regardless of what the skier does. A balk occurs when the skier refuses the ramp by either skiing to the left of the ramp and releasing the handle or by following the boat past the ramp while holding on to the rope.
- (e) The outcome of each attempt shall be communicated to the skier, including the distance and any reride possibilities, before the boat proceeds to any subsequent attempt by the same skier.

9.04 Falls

- (a) Definition: See Rules 8.06 and 8.07.
- (b) A fall within or outside the jump course shall be registered as a pass.
- (c) In the event of a fall, if the skier is not on his skis within three minutes from the time the towboat returns to pick him up, he shall receive no further jumps.
- (d) If damaged equipment is involved, see Rule 9.15.

9.05 Boat Selection

See Rules 8.02(d), (e) and (f).

9.06 Boat Speed

The boat speed for each attempt shall be chosen by the skier from those listed in the table in the Appendix, up to the maximums listed below. In addition, the skier shall be given a choice of having the speed control deliver a faster speed throughout the second segment, or having the speed control return to the baseline (RTB) speed for the second segment. The speed control shall be engaged before the 180m (590 foot) buoy.

- (a) Open Men; Masters Men; Men 1, 2: 57 kph /35.4 mph
- (b) Open Women; Women 1, 2; Men 3: 54 kph/ 33.6 mph
- (c) Women 3; Men 4, 5; Boys 3; Girls 3: 51 kph/31.7 mph
- (d) Women 4, 5, 6; Men 6, 7, 8, 9, 10, 11: 48 kph/29.8 mph
- (e) Women 7, 8, 9, 10, 11; Boys 2; Girls 2: 45 kph/28.0 mph

9.07 Boat Path

The jumper shall tell the boat driver at what off-set distance to pass the ramp. The boat shall follow a straight path parallel to the course and parallel to the right side of the ramp.

9.08 Officials

- (a) Boat Judge: A judge shall ride in the boat to check speeds, observe the boat path and alone determine if the skier lands and skis away in skiing position without falling. He shall be authorized to grant rerides for deviations there from, as governed by Rules 9.03, 9.06 and 9.07.
- (b) Event Judges: The Chief Judge shall appoint two event judges in addition to the judge in the boat.
- (c) Boat Timers: When speed control is not being used, a boat timer shall ride in the boat to check speeds with a stop watch (see Rule 9.09), and a backup timer is also required. Automatic timing devices may be substituted for the boat timers.
- (d) Boat Crew: There shall be two or three people in the boat.
- (e) Masterboard Operator: Rated judges shall be assigned as masterboard operators where possible. When not possible, a non-rated, competent person may be used.

For the video system, there shall be two designated officials operating the system who shall jointly agree on the marking of the impact point. If these two officials disagree, the Chief Judge (or his designee) will resolve the disagreement.

- (f) Meter Readers: Rated judges shall be assigned as meter readers where possible. When not possible, a non-rated, competent person may be used.

9.09 Timing

- (a) General: The boat speed shall be validated by timing on each pass from the speed control system (see 8.10(g)). The timing shall be in two segments. The first segment shall be from the timing course start buoy 72 meters (236' 1") before the jump to the intermediate timing course buoy 10 meters (32' 10") past the jump. The second segment shall be from the 10-meter buoy to the timing course end buoy 51 meters (167' 3") past the jump. **Timing will be required to be recorded in three segments of 52m, 30m, and 41m, however two segment timing will be controlling.** Acceptable timing methods may be magnetic point to point or calculated virtual timing provided such methods and timing components of the speed control system are tested and approved. It is not necessary to time the jump pass if the skier falls in the course before the boat enters the timing course. In the case where a skier refuses the ramp or falls on the approach to the ramp, the maximum tolerance allowable shall be increased by .05 seconds and only first segment timing is required. This may be done by either subtracting .05 seconds from the maximum speed tolerance or by adding .05 seconds to the time recorded.
- (b) Tolerances: Tolerances shall be in accordance with Rule 9.17.
- (c) If the boat path is between the jump ramp and the 15-meter buoys, timing is not required, but is recommended if practical.
- (d) The following table summarizes the boat time and reride situation for all timing combinations when the skier has chosen a speed below the maximum allowable for his division:

Boat Times and Reride Situations
(Skier below Division Maximum Speed)

Segment		Action
1	2	
Any	Fast	Only if faster than fast tolerance for division maximum, and if best distance in set, then mandatory reride and may improve score. (See 9.10(b)(1)(i))
OK	---	None
Fast	---	Mandatory Reride if exceeds fast tolerance for divi-

		sion maximum (score not protected), otherwise optional reride (with protected score)
Slow	---	Optional reride (with protected score)

- (e) The following table summarizes the boat time and reride situation for all timing combinations when the skier has chosen the maximum speed allowable for his division:

Boat Times and Reride Situations
(Skier at Division Maximum Speed)

Segment		Action
1	2	
OK	OK	None
OK	Fast	Mandatory reride if best distance in set, may improve score. (See 9.10(b)(2)(ii)(2) and 9.10(b)(2)(ii)(3))
OK	Slow	Optional reride (with protected score). Use RTB slow column if applicable. (See 9.17)
Slow	OK	Optional reride (with protected score)
Slow	Fast	Mandatory reride if best distance in set, otherwise optional (with protected score)
Slow	Slow	Optional reride (with protected score). Use RTB slow column if applicable. (See 9.17)
Fast	OK	Mandatory reride
Fast	Fast	Mandatory reride
Fast	Slow	Mandatory reride

- (g) Speed Control: If the boat officials feel that a significant change must be made in settings for the jump event to obtain the proper speed, they will notify the skier of the change when it is made, before his next jump.

9.10 Rerides

- (a) Unfair Conditions: See Rules 7.01, 7.02 and 7.03.
- (b) Time Out of Tolerance: See summary tables in Rule 9.09(e) & 9.09(f).
- (1) When the Skier has selected a speed below the maximum allowable for his division:
- (i) If the first segment time exceeds the fast speed tolerance for the maximum speed allowable for his division, then an immediate reride shall be mandatory.
 - (ii) If the first segment time does not exceed the fast speed tolerance for the maximum speed allowable for his division, then:

- (a) If the first segment time is outside the tolerance range for the selected speed, the skier may take an immediate optional reride, with a protected score.
 - (b) If the second segment time exceeds the fast speed tolerance for the maximum speed allowable for his division on a successful jump, and the distance recorded is greater than any of the other jumps in the round by the skier, a reride shall be mandatory at the end of the skier's set.
- (2) When the skier has selected the maximum speed allowable for his division:
- (i) If the first segment time is fast, an immediate reride shall be mandatory.
 - (ii) If the first segment time does not exceed the fast speed tolerance for the maximum speed allowable for his division, then:
 - (a) If either segment time is slow, the skier may take an immediate optional reride, with a protected score.
 - (b) If the second segment time is fast on a fall, the skier may take an immediate optional reride.
 - (c) If the second segment time is fast on a successful jump, and the distance recorded is greater than any of the other jumps in the round by the skier, a reride shall be mandatory at the end of the skier's set.
- (3) If the time for either segment is missed, a reride shall be mandatory.
- (c) Distance Measurement Out of Tolerance: See Rule 9.12(e).
 - (d) Procedure: If a reride is granted, it shall be taken immediately at the same speed as that requested for the affected jump. If there are more than two rerides, the skier shall have the option of requesting a five-minute rest before continuing. Also see Rule 7.02.
 - (e) Multiple rerides for distance measurement out of tolerance (see Rule 9.12(e)) are to be resolved sequentially in the order in which they occurred. Other rerides will be taken immediately following the run in which they occur, except when the second segment only is fast (see 9.10(b)(1)).
 - (f) Once a skier has taken a definite cut toward the ramp, he automatically waives any reride request regarding any conditions encountered prior to the start of the timing course.

- (g) When weather, tournament-supplied equipment, or some other reason not the fault of the skier causes a delay of more than ten minutes between jumps, the skier shall have the option of requesting an unscored jump to be taken before the remaining jump(s). However, the Chief Judge, with the approval of the majority of the Appointed Judges, may deny this option if there is reason to believe that further delays will preclude finishing the tournament in a timely manner or otherwise work to the disadvantage of the remaining skiers.

9.11 Handle Throws

A contestant may refuse to enter the official jump course on any pass by throwing the handle in the air before the 180-meter (590') course entry buoy. He shall not be penalized for so doing, provided the refusal was for a reason acceptable to a majority of the Event Judges. The skier must be ready to ski immediately upon the boat's return. Should the skier not be ready or should the reason for the handle throw not be acceptable, one pass shall be deemed as taken. (See Rule 9.15 regarding damaged equipment.)

9.12 Distance Measurement

- (a) General: Jump distances shall be derived using sightings taken from a system of Johnson-type meter stations, which shall be set up according to guidelines described in the Technical Handbook. Distances shall be measured from a point at the water line directly below the center of the top edge of the jump ramp, to the point where the heels of the skier reach their maximum depression in the water (this point is usually indicated by a plume or spout of water which rises after the skier's landing).

Alternatively, if video jump distance measurement is used, the distance shall be measured to the skier's impact point in the water, closest to the ramp (first point of impact) and then an adjustment offset of 2.1 meters shall be added. If video jump measurement is used, video backup methods (video taping) may be used, or a standard meter system may be used as backup. The calculated distance shall not be displayed until the impact point is decided upon.

The approximate distance (\pm two feet) shall be communicated to the skier after each scoring jump, before the boat approaches the course for a subsequent jump by that same skier.

- (b) Rounding: All distances shall be calculated to the nearest whole foot. Partial distances of one-half foot or more will be rounded up to the next higher whole foot, while partial distances of less than one-half foot will be dropped. For Record Capability tournaments, metric distances shall be calculated as well, and in similar fashion rounded to the nearest whole tenth of a meter.
- (c) Three Meter System:

- (1) Three meter sighting stations of two meters each or video jump shall be used at all tournaments Class C or higher. At Class C tournaments or below, only one meter at any station may be used at the option of the Chief Judge. Where only one meter is used at a station, the single sighting value from that meter shall be used wherever the average value is called for below.
 - (2) The point of the landing is defined as the center of the inscribed circle which is tangent to all three sides of the triangle formed by the three average sightings from the meter stations. The distance is calculated from that landing point back to the ramp. The size of the triangle is defined as the diameter of that inscribed circle.
 - (3) If the top and bottom sightings from any single meter station are more than 0.6 meter (2') apart at the point of landing, then the average value and the single sighting with the smaller value will each be tried in turn, and whichever of these produces the smaller triangle will be used to derive the official distance.
 - (4) If the official resolution of a particular set of sightings according to the above rules produces a wide triangle, and that set of sightings included a spread in excess of the 0.6 meter test limit at only one of the meter stations, which yielded a smaller triangle size by using the average rather than the shorter reading alone, then the longer reading from that station may be tried alone and used as official if it eliminates the wide triangle.
 - (5) At Class C tournaments or below, a jump which produces an official triangle greater than 0.9 meter (3') shall be classified as a wide triangle. For Record Capability tournaments, a jump which produces an official triangle greater than 0.6 meter (2') shall be classified as a wide triangle. A jump classified as a wide triangle under either of these definitions shall be treated according to the provisions of Rule 9.12(e) below, with the short vertex and long vertex distances defined as the distances to those vertices of the triangle which are closest and furthest from the ramp, respectively.
- (d) Two Meter System: In Novice or Class I tournaments where two meter stations of two meters each are being used, the landing point is defined as the intersection of the average sightings from those two stations. If one (or both) pair(s) of sightings is more than 0.6 meter (2') apart at the point of landing, the intersections using each of the individual readings from that station (or stations) will be examined separately. If the difference between the distances from the closest and furthest intersections back to the ramp is greater than 1.2 meters (4'), then that jump shall be classified as a wide triangle and treated according to the provisions of Rule 9.12(e) below, using the distances from the ramp to those closest and furthest intersections as the short vertex and long vertex, respectively.
- (e) Wide Triangles: At the time it occurs, a jump which is classified as a wide triangle will tentatively be scored as the distance to the short vertex, and the

skier will continue. If, after completing all three attempts in a set, a skier has had one or more jumps classified as a Wide Triangle, each of these shall then be resolved, in the order in which they occurred, according to the following provisions:

- (1) If the long vertex is less than or equal to the official distance of another of his jumps (or to the short vertex of another wide triangle jump), then the short vertex of that jump will be recorded as official, and the skier will have no options on that jump.
 - (2) If the long vertex is longer than the longest official distance (or longest short vertex of another wide triangle jump), then the skier will have the option to either accept the short vertex as the official distance, or to take the jump again. If the skier elects to take the jump over, the result of that reride will be official, except that it may not be scored to a distance greater than the long vertex nor less than the short vertex of the original wide triangle jump.
 - (3) In the event of a subsequent tie, where the short vertex of a jump which was originally classified as a wide triangle becomes an issue in determining placements, the competitor(s) affected shall then have the option of accepting that short vertex or of taking a reride. If the reride is taken, the outcome shall be official, although it may not be scored to a distance greater than the long vertex nor less than the short vertex of the original wide triangle jump.
- (f) Video Systems: Video-based jump distance measurement systems interface video and computer technologies, and permit a frozen video image of a skier's landing to be portrayed on a computer screen, and measured through translation from the pixel-based coordinates on that screen, back to coordinates on the water surface. The field of view displayed must include sufficient visual reference markers on the water surface, whose absolute locations relative to the jump ramp are known. When video jump measurement is used, a check buoy must be placed near the center of each box, in approximate line with either the near or far horizontal side of the box (from the camera), and its exact location as measured by survey (or other means as appropriate for Class C and below tournaments) and by the video jump system must be recorded on the TC Report (or Chief Judges Report). The check buoy for each box shall be independent of the four required reference buoys for that box. For Record Capability purposes, all reference markers must be included in the survey of the jump site.

The distance shall be measured to the skier's impact in the water, closest to the ramp (earliest point of ski contact), and then an adjustment offset of 2.1 meters shall be added from that point, to maintain comparability to meter-based measurement systems where operators sight to the plume. Where such a measurement system is used, videotape backup is recommended, or a manual meter system may also be used as backup.

Such video measurement systems must be configured in a fashion so that the maximum differential in jump distances which would result from one-pixel movements on the video screen, either of any of the required reference point markers or of the landing point marker itself, and in either the horizontal or vertical direction - not exceed the following values at any point in the "operating field of view", which means the central 80% of the screen area. This criterion value depends on the class of the tournament, as follows:

World Record (Class R)	10 cm (4 inches)
Standing List (Class L and E)	15 cm (6 inches)
Local Tournaments (Class C)	20 cm (8 inches)

Any existing video setup can be evaluated against this standard by testing actual movements of the reference markers and landing point markers, and observing the reported changes in the calculated landing location which results from such movements between adjacent pixels. Such manual evaluations need to be systematically conducted throughout the expected operating range of the setup. Alternatively, the Technical Committee has prepared a planning and analysis model (in the form of a spreadsheet template) which may be used to evaluate any proposed Corson Video Jump System site configuration against this standard. The use of this latter tool is required for Record Capability tournaments, and a copy of the printout from that spreadsheet is to be attached to the Technical Controller's Report.

- (g) Alternatively, the Technical Committee may approve the use of systems based on other technologies, provided that proper verification and proof is given to the Technical Committee at least 60 days before the date of the proposed official use.

9.13 Scoring

- (a) Each contestant's longest single jump distance, in feet as determined according to Rule 9.12, shall become his official score for the event. Where a computer is being used that calculates metric distances (see Rule 9.12(b)), the metric distance of the longest single jump shall also be reported.
- (b) Scoring Ties: In the case where two or more skiers have the same official score, the skier with the longest metric distance (if available) shall be declared the winner. In the event a tie exists, it shall be run off as provided under Rule 9.14.

9.14 Ties

- (a) If a tie results, it shall be run off, with a new drawing for order. Each tied contestant shall be allowed two passes through the course, with both jumps being scored. Repeated ties shall be run off in the same manner until broken.

- (b) Ties shall be run off in the first five places at Regionals and Nationals, and the first three places in all other tournaments.
- (c) A two-way tie for second place would eliminate third place, while a three-way tie for second place would eliminate third and fourth places, etc.
- (d) Ties in multi-round tournaments shall be determined as follows: Longest single jump; if a tie still exists the next longest jump; etc.

9.15 Damaged Equipment

If a skier notices that his equipment is damaged after a handle throw, a pass or a jump, the event judges may grant him, upon immediate request, three minutes to repair or change the damaged equipment. The three-minute period should start upon the request being granted by the judges. If the skier is not ready to ski at the end of the three-minute period, he shall not be allowed to continue in that round.

9.16 Jumping Equipment and Definitions

- (a) **Jump Meters:** Meter stations shall be equipped with AWSA-approved protractors and sighting arms. Sightings from each meter shall be taken to the sighting mark on the ramp (Rule 9.16(c)(9)) and to the 15ET buoy. The upper and lower meters at each station must not differ on either of these sightings by more than 0.1 degree for Record Capability tournaments, or not more than 0.2 degree at Class C tournaments. For both sightings, the average of the readings at each station shall be taken, and must produce a triangle size on both these points (as per Rule 9.12(c)(2)) no greater than 15 cm (6") for Record Capability tournaments, or no greater than 23 cm (9") for Class C tournaments.
- (b) **Distance Derivation Devices:** Distances shall be derived either by a computing device, or on a scale model manual plotting board which has been set up and verified according to guidelines described in the AWSA Technical Handbook. For Record Capability tournaments, a computing device must be used as the primary method. Where a computing device is used, either the manual plotting board or an independently-powered computing device shall be provided as a backup measuring device, and should it become necessary to use that backup device, the distances it produces shall be official. Any such computing devices shall be checked by the Chief Judge or his designate, and must be shown to produce the listed results for all the test cases that appear in the Computer Benchmark section of the Appendix.
- (c) **The Jump Ramp:** The jump ramp shall be an inclined plane with mounted aprons set at an angle in relation to the ramp. The ramp shall meet the following specifications:
 - (1) **Width:** 3.7 meters (12') to 4.3 meters (14' 1.25") at all points. 4.3 meters is the preferred width.

- (2) Length Out of Water: 6.4 meters (21') to 6.8 meters (22' 3.75") at all points.
- (3) Length Under Water: 50 cm (20") minimum.
- (4) The following ratios of ramp height at take-off edge to ramp length out of water shall apply: Masters Men, Men 1 and 2 jumpers will have the option of choosing either the .255 or .235 ramp; Boys 3 shall use the .235 ramp unless they can show a certified result of a jump of 38 m (125 feet) on the .235 ramp, in which case they may opt to jump on a .255 ramp; Open Women shall use the .235 ramp unless they can show a certified result from a Record Capability tournament of a jump of 40 m (132 feet) on the .235 ramp, in which case they may opt to jump on a .255 ramp; Open Men will have the option of choosing either the .271 or .255 ramp; and all other divisions will be set at .235. All of these ratios shall be set to within $\pm .003$ for all Record Capability tournaments, or to within $\pm .005$ for all other tournaments. (See Ramp Setting Chart in the Appendix.) At the option of the sponsoring club, any division may jump at a ramp ratio of less than .235.
- (5) Surface: The surface must be flat with a maximum deviation of 5 cm (2") from a plane, (2.5 cm) (1") for Record Capability tournaments.

For Class N tournaments, greater deviations from a plane may be allowed, but this is not recommended.

- (6) Aprons: Aprons shall extend the full length of the ramp and shall be at least 20 cm (8") under water when the ramp is raised to its full height. A left-sided apron is not required. The recommended apron angle is 30 degrees from vertical.

For the first 1/3 of the apron at and below the water, the curtain may be approximately 60 degrees from vertical. It shall be radiused and blended to the surface to prevent skis from catching.

- (7) Ramp Markings: 6.4-meter and 6.7-meter (21' and 22') length markings, clearly identified, shall be placed on the aprons and/or ramp surface so that they are readily visible. Extra marks, if identified, are allowed and desirable.
- (8) Color Specifications: The ramp aprons and ramp surface shall be of different colors, both of which shall be different from the water surface. The ramp surface shall be one solid color without borders or decorations of any sort.
- (9) Vertical Line: A 1 - 3 cm (0.25" - 1") wide vertical line of contrasting color shall be plainly marked or painted at the center of and just below the take-off edge for meter sighting purposes. This vertical line may ex-

tend over onto the jump surface not more than 8 cm (3") to facilitate locating the centerline during surveys. The jump ramp must be securely anchored in place such that the center take-off edge will not vary more than the sighted width of the crosshair on all meters after coming to static rest. "Static rest" is the position assumed by the ramp in ambient water not affected by boat wakes, skier's wakes, or backwash.

- (d) Buoys: Colors of buoys shall be in accordance with the Official Jump Course Diagram in the Appendix. For specifications see Rule 8.09. The 15MT buoy may be sunk below the level otherwise specified for boat guide buoys, although it must still be clearly visible.
- (e) Tow Lines: Tow lines used in the Jumping event must conform to Rule 8.04 and the Tow Lines Dimensions Chart in the Appendix. Tow line recoil tubes may be used at any and all tournaments at the discretion of the Chief Judge.
- (f) Skier Furnished Jump Handle: The contestant may furnish his own handle, for which he is entirely responsible, with an attaching loop to attach to the tournament line, and which must comply with the handle section dimensions in the Appendix. The contestant's handle may be of any material. For Class E tournaments personal handles shall be measured by the dock starter immediately before the skier skis.
- (g) Skier Furnished Jump Towline and Handle: The contestant may furnish his own jump towline and handle, for which he is entirely responsible. The contestant's towline and handle may be of any material which must comply with the dimensions for total length in the Appendix (23m +/- 30cm).

9.17 Tolerances

The accuracy of all speeds shall be determined by the tables which appear in the Appendix. The measured times through the two segments of the timing course must fall within the tolerances listed in the appropriate column of this table, as specified in 9.10(b). If the skier chooses the faster option and then does not engage the jump switch at the base of the ramp and in the opinion of the boat judge did not cut aggressively enough to do so, or if the skier chooses the return to baseline option, then the "RTB" second segment slow time tolerances shown in the table shall apply.

- (a) Class C Tournaments or Below: It is recommended that the "Standard Tolerance" column in the tolerance table in the Appendix be used, unless the quality of the boat driving and/or water conditions do not permit its use with an absolute minimum of rerides. Alternatively, the "Wider Tolerance" column may be used, and in this case only Expert ratings or below may be granted.
- (b) Record Capability Tournaments: At maximum speeds for the skier's age division, the "Record Tolerance" column shall be used, and at lower speeds the "Standard Tolerance" column shall be used.

9.18 Disqualification

A jumper shall receive no further jumps in a round if, after leaving the boat's wake on a definite cut to the ramp, the jumper elects to pass between the boat course and the ramp, whether or not he retains the tow line. A judgment decision is required by a majority of the Event Judges as to whether the cut is "definite." Also see Rule 7.07.

RULE 10 - SLALOM

10.01 General

The contestant shall follow the towboat through the entrance gate of the slalom course, pass around the outside of any or all six buoys, at his discretion, and proceed through the far end gate (constituting a pass). If the contestant has not missed any buoys or gates, the boat shall make a turn and re-enter the course from the opposite end. The skier shall continue in this manner until he falls or misses a buoy or gate. The boat shall be stopped at the end of each pass, unless the skier requests at the starting dock to continue at his own risk. (See Official Slalom Course Diagram in the Appendix.)

Passes through the slalom course may not be limited to less than four passes.

At the discretion of the Regional Executive Vice President, all slalom passes in Class C and below tournaments may be run in the same direction if the site is not suitable for running them in opposite directions.

10.02 Slalom Course

The dimensions of the official slalom course shall be as shown in the Official Slalom Course Diagram in the Appendix. For buoy specifications, see Rule 8.09.

Slalom may be run on an extended or "overlapping" course setup, which provides two complete slalom courses that share some gates in common, provided that each such complete course is otherwise in tolerance according to the Official Slalom Course Diagram in the Appendix. In such a layout, it is recommended that the orange entrance gate buoys be used to mark the "true" entrances, which are inset from each end. The outermost skier gates (which are used as the exit gates only) should be of a contrasting color to avoid confusion when re-entering the course. Where such a layout is to be used, the details shall be clearly pointed out to all competitors.

10.03 A Miss

It is a miss to ride inside a turn buoy or outside the entrance or exit gate, or to ride over, straddle, or jump a turn buoy, but there is no penalty for grazing a turn or gate buoy with the ski or part of the body. "Riding over" shall be defined as hitting a turn or gate buoy with the ski so as to move it significantly from its

position or temporarily sink it. Hitting a turn or exit gate buoy less severely shall be considered as "grazing." (See chart in appendix)

10.04 A Fall

- (a) Definition: See Rule 8.06.
- (b) A fall inside or outside the course concludes the run at that point.
- (c) The stopping of the boat in slalom at the end of the course will not be scored as a fall.

10.05 Boat Selection

See Rules 8.02(d), (e), and (f).

10.06 Boat Speeds and Line Lengths

- (a) The minimum starting speed for all divisions shall be 25 kph (15.5 mph). ***At the option of the LOC, a skier may start below the minimum speed and the pass(es) shall not be scored.*** At the option of the sponsoring club as stated in its tournament announcement, or by majority vote of the Appointed Judges, the number of passes may be limited to a specific number. A speed increment is 3 kph (1.86 mph).

Male Divisions	Maximum Speed	Female Divisions	Maximum Speed
Boys 1	49/(30.4)	Girls 1	49/(30.4)
Boys 2	55/(34.2)	Girls 2	52/(32.3)
Boys 3	58/(36.0)	Girls 3	55/(34.2)
Men 1	58/(36.0)	Women 1	55/(34.2)
Men 2	58/(36.0)	Women 2	55/(34.2)
Men 3	55/(34.2)	Women 3	55/(34.2)
Men 4	55/(34.2)	Women 4	55/(34.2)
Men 5	55/(34.2)	Women 5	52/(32.3)
Men 6	55/(34.2)	Women 6	52/(32.3)
Men 7	52/(32.3)	Women 7	49/(30.4)
Men 8	49/(30.4)	Women 8	49/(30.4)
Men 9	49/(30.4)	Women 9	46/(28.6)
Men 10	49/(30.4)	Women 10	46/(28.6)
Men 11	49/(30.4)	Women 11	46/(28.6)
Open Men	58/(36.0)	Open Women	55/(34.2)
Master 55k	55/(34.2)		

- (b) For all divisions, minimum starting speed at the National Tournament shall be 31 kph (19.3 mph), unless the Level 7 ranking list Cut Off Average as of the Cut Off Date is less than the minimum National starting speed, in which case the starting speed shall be the normal starting speed per 10.06(a).
- (c) The boat speed shall be advanced by 3 kph (1.86 mph) on each pass until the maximum speed for the division is reached (see Item (a) above), at which time the speed will remain constant and the line will be shortened in accordance with the table below. A skier may elect to start at a speed higher than his division maximum speed, up to his respective Open Division maximum speed and may not return to his division maximum speed on subsequent passes. Any passes skied at that higher speed shall receive credit for buoys as though they were being run at his division maximum speed. See Tow Lines Dimension Chart in the Appendix, and Rule 10.16(c).

1st cut - to a 18.25 meter (59' 10.5") 2nd cut - to a 16 meter (52' 6") 3rd cut - to a 14.25 meter (46' 9")	} ± 15 cm (5.906")
4th cut - to a 13 meter (42' 7.8") 5th cut - to a 12 meter (39' 4.4") 6th cut - to a 11.25 meter (36' 10.9") 7th cut - to a 10.75 meter (35' 3.3") 8th cut - to a 10.25 meter (33' 7.6") 9th cut - to a 9.75 meter (31' 11.9") 10th cut - to a 9.50 meter (31' 2") 11th cut - to a 9.25 meter (30' 4.2")	

All subsequent cuts shall be made in .25-meter (9.844") increments.

- (d) A skier shall have the option of selecting his starting speed (at or above the minimum for his division) and rope length.
- (1) If any but the minimum starting speed for the skier's division is selected and the first pass is completed, the skier is credited with all skipped passes. If the selected pass is missed, the skier will receive credit for actual buoys rounded as if it were the minimum starting speed.
- (2) With the exception of items (a) and (b) above and at the option of the skier, slalom may be run starting with any line length, below maximum speed. When the maximum speed is reached, if the skier makes a complete pass, he then receives credit for any longer line pass(es). If the pass is missed, he will receive credit for buoys as if it were the 23-meter line pass.
- (e) Upon completion of a pass (defined as a score of six including entrance and exit gates) the skier shall have the option of designating a faster speed and/or shorter rope length for the next pass. If any but the next consecutive speed or rope length is selected, the skier must complete the selected pass

to receive credit for the skipped pass(es). If the pass is not completed, the skier will receive credit for buoys at what would have been the consecutive rope length or speed.

10.07 Boat Path

The boat path is intended to be a straight line along the centerline of the course. In no case shall any part of the towboat deviate outside the bounds of the boat gates. The bounds of the boat gates shall be defined by the center of the attachment point of each buoy.

10.08 Officials

- (a) Boat Judge: One event judge shall ride in the towboat. The boat judge shall judge whether the skier passed through or missed the end gates, and shall judge the credit to be received by the skier for each buoy in accordance with Rule 10.12, and shall communicate his results to the scorers immediately after each pass. The boat judge shall also check the boat time(s) for each pass and identify reride situations in accordance with Rules 10.09 & 10.10. The boat judge shall also observe the boat path (see Rule 10.07). If any part of the boat deviates outside the bounds of the boat gates, the boat judge shall award an optional reride if the path of deviation was a disadvantage to the skier. If it was to the skier's advantage, a reride is mandatory. Each event judge must continue scoring a run even though he feels the skier missed a gate or buoy.
- (b) Tower Judges: There shall be four event judges stationed in the slalom judging area in accordance with Rule 10.16(a). Each tower judge shall independently judge the credit to be received by the skier in accordance with Rule 10.12, and shall communicate his results to the scorers immediately after each pass. The entrance and exit gates shall be judged by the boat judge and the two judges with the best view of each gate, (except when optional video gate judging from a central tower is used), as determined by the Chief Judge. Each event judge must continue scoring a run even though he feels the skier missed a gate or buoy.

As an option, two judges may be used in slalom with the same height requirements referenced above. It is recommended that the two tower judges be placed on opposite sides of the course. Additionally, there shall be video feeds from cameras located at each end of the slalom course, positioned with an unobstructed view of the entrance gates, and placed at the required angle to the gates at least 3 meters (10') above the water. The cameras shall be adjusted to show both gates in clear focus, and equipped with optical (not digital) magnification of sufficient power to display the gate at least 1/6th of the full width of the screen (1/3 width or larger is recommended). If a camera is located more than 100 feet back from the course centerline, it is recommended that it be elevated approximately ten percent above the water (one foot in height for each ten feet back from the course centerline). These camera feeds shall be displayed on a monitor and taped. Each judge shall in-

dependently call the entrance gate by observing the monitor. If one or both judges did not observe the entrance gate, or the two judges should disagree, then the judge(s) would replay the video (at normal speed, slow motion, or frame-by-frame) to make the call. (If video replay malfunctions, the boat judge shall call the gates.) The Appointed Judges shall determine the time at which the video review will take place and if the video review is to be after the conclusion of the skier's last pass, then the skier shall be advised that he is continuing at risk, pending the video review. If the judges disagree after having reviewed the video, the Chief Judge (or his designee) will cast the deciding vote. The exit gate will be viewed directly, but the video may be used by one or both judges to resolve any questions. The use of video gate cameras, as described above, shall be mandatory at the US Nationals, regardless if using 3 or 5 judges.

A camera feed from the boat may be used and be monitored on the tower by another judge who will advise the Chief Judge if he disagrees with the event judges' decision. In this case, the Chief Judge will ask the event judges to review that video. This is a separate optional rule and may be used with 3 or 5 judges, or need not be used. The Appointed Judges shall determine the time at which the video review will take place and if the video review is to be after the conclusion of the skier's last pass, then the skier shall be advised that he is continuing at risk, pending the video review.

If a skier or team representative believes that there was an error in the score, he may challenge it by notifying the Chief Judge before the next skier goes out, and by putting up \$100. The Chief Judge and a designated review judge will review the video (boat or gate video). If they both agree on a score, that will be the given score. If they disagree, or agree that the video does not clearly overrule the score given by the judges, then that score will stand. The \$100 will be returned only if the original score was changed. If the funds are not returned to the skier, they shall be forwarded to the AWSEF as a contribution in the skier's name.

For Class C tournaments and below, at the option of the Chief Judge, three judges (two tower and one boat) rather than five may be used to score slalom and video gate cameras are not required.

For Class C tournaments and below, if no slalom judging tower is used, the judges shall be stationed with the best possible view of the course.

In Class I and Novice tournaments, the number of judges shall be at the option of the Chief Judge. Slalom may be judged by the boat judge alone.

- (c) Boat Timers: When speed control is not being used, a boat timer shall ride in the boat to check speeds with a stop watch (see Rule 10.09), and a backup Timer is also required. Automatic timing devices may be substituted for the boat timers.

- (d) Boat Crew: There shall be two or three people in the boat.

10.09 Timing

- (a) The boat speed shall be validated by timing on each pass from the speed control system (see 8.10(g)). In the event the speed control system fails to get an accurate time because of a malfunction or missed time, see Rule 10.10(b) (3) and (4). Where the time shows that the speed is slower than allowed, a reride is mandatory; where faster, a reride is at the contestant's option if the pass was not complete.
- (b) Timing Segments: Timing shall be from the entrance gate to the boat path alignment gate or exit gate following the buoy at which the last full point is scored in the pass. (Refer to applicable All Buoy Timing Charts in the Appendix) Acceptable timing methods may be magnetic point to point or calculated virtual timing provided such methods and timing components of the speed control system are tested and approved.
- (c) Official times and tolerances for the various slalom speeds are listed in the Appendix. Also see Rule 10.17.

10.10 Rerides

- (a) Unfair Conditions: See Rules 7.01, 7.02 and 7.03.
- (b) Times Out of Tolerance
 - (1) If the time is too slow, a reride is mandatory.

At class E, L, and R events, if the pass was not complete, the skier may not improve his score over that obtained on the slow pass. However, if the speed is so slow that it is equal to or below the fast tolerance of the next slower pass, then the skier may improve his score on the reride.

If the slow time pass was complete, the skier has the option to skip to any higher speed and/or shorter line length instead of repeating the pass. If the skier exercises this option and makes a perfect pass, he receives credit for both passes. However, if the pass is missed, he will receive credit for the buoys as if it were the lower, skipped pass.

- (2) If the time is fast and the skier falls or misses, the skier shall have the option of a reride but shall not be scored less than the score obtained on the pass leading to the reride.
- (3) Missed Times: If the applicable segment time is missed, the provisions above shall be applied as though the time was slow, except that the skier may improve his score, may accept the highest score with a good applicable segment time, or receive an optional reride with a protected

score equal to the highest score with a good applicable segment time. (Also see Interpretations)

- (4) If the boat time is OK or fast on an incomplete pass, but the speed control has failed or malfunctioned and the skier received an irregular or inconsistent speed as a result, the skier may be given an optional reride with a protected score. If the time was slow the score is not protected, but the skier may improve. If the time is missed see rule 10.10(b)(3). (See 7.01 and 8.10(f) and Rules Interpretations).

(c) Boat Path Deviates Outside the Bounds of Boat Gates: See Rule 10.08(a).

(d) Procedure:

- (1) Immediately following any one pass for which the timer records a speed that requires or makes optional a reride for the skier, the skier shall be notified of the facts and told he must or may repeat that pass.
- (2) If a reride is to be taken, the boat shall return through the course in an unscored pass, and the reride shall then be given in the original direction through the course. The boat will proceed to the proper end of the course, stop, and drop the skier into the water just as if the line were to be shortened, and then proceed.
- (3) If there are more than two rerides, the skier shall have the option of requesting a five-minute rest before continuing. Also see Rule 7.02.
- (4) When weather, tournament-supplied equipment, or some other reason not the fault of the skier causes a delay of more than ten minutes between slalom passes, the skier shall be allowed an unscored warm up pass, in the opposite direction of the reride, with a protected score on passes already completed, ***or the skier may start over without a protected score.*** However, the Chief Judge, with the approval of the majority of the Appointed Judges, may deny this option if there is reason to believe that further delays will preclude finishing the tournament in a timely manner or otherwise work to the disadvantage of the remaining skiers.

10.11 Handle Throws

A contestant may refuse to enter the official slalom course on any pass by throwing the handle in the air before the entrance gate. He shall not be penalized for so doing, provided the refusal was for a reason acceptable to a majority of the event judges. The skier must be ready to ski immediately upon the boat's return. Should the skier not be ready or should the reason for the handle throw not be acceptable, he shall be disqualified from the remainder of the event for that round. See Rule 10.15 regarding damaged equipment.

10.12 Points for Buoys

A buoy not missed is credited as follows up to the point of the first miss:

- (a) $\frac{1}{4}$ point when the skier crosses the C-D and X-Y lines in skiing position (Rule 8.07) before the buoy to be rounded (See Slalom Scoring Diagram in the Appendix); however, if the skier passes on the inside of the buoy, he shall not receive the $\frac{1}{4}$ point.
- (b) $\frac{1}{2}$ point when the skier has re-crossed the C-D line in skiing position before the level of the next buoy or end gate.
- (c) 1 point when the skier has crossed the line of the gate buoys before passing the level of the next buoy (or the end gate in the case of the final buoy) with a tight line under the power of the boat without falling.

The intent of the tight line is to ensure the safety of the skier. This means that if the skier can only cross the line of the buoys with a slack line then he will not get the full point so there is no reason to try that. The end gate case is different because of the spacing and thus if the skier can cross the gate line before the end gate buoy and ski away he will be awarded the full buoy.

- (d) For judging purposes, the front foot of the skier shall be used to determine the point at which the skier crosses the quarter, half, and full point buoy lines (or the end gate in case of the final buoy).

10.13 Scoring

- (a) The scorers shall receive the judges' individual tabulations after each pass. Any disagreement shall be decided by a majority of event judges before the next pass or before the next competitor is permitted to ski.
- (b) Points are earned toward placement in the event for each full, half, or quarter point scored in succession without a miss of a buoy or end gate (Rule 10.12).
- (c) The contestant with the most consecutive points earned at the shortest rope length at the fastest speed where the miss occurred shall be the winner of the event. In a case where two or more skiers have the same number of consecutive points but at different boat speeds and/or rope lengths, the skier with the fastest boat speed where the miss occurred shall be declared the winner except when skiing above division maximum the speed will be as if at division maximum. If they still have the same score, the shortest rope length shall be used to determine the winner.
- (d) Scoring Waived Passes:
 - (1) Miss on First Pass: The skier shall receive only the points scored without additions for the waived passes.

- (2) Skier Has Complete Pass: Six points shall be added to the skier's score for each skipped or waived passes.
- (3) Skier Has Complete Pass but Slow Boat Speed and Exercises Option to Advance to the Next Pass per Rule 10.10(b)(1): If the skier makes a complete pass, he shall receive credit for both passes. If the pass is missed, the skier shall receive credit for buoys as if it were the lower, skipped pass.
- (4) Skier Elects the Option to Start at Any Line Length Other Than 23-meter at Below Maximum Speed: He shall be credited with six buoys for every pass he makes below the maximum speed. When the maximum speed is reached, if the skier makes a complete pass, he shall receive credit for any longer length passes. If the pass is missed, he shall receive credit for buoys as if it were the 23-meter pass.
- (e) Scoring Rerides: The affected pass shall be re-scored in accordance with the above (Rules 10.13(a) through (c)) and with Rules 10.04 and 10.12.
- (f) Scoring Ties: The skier who scores the most consecutive points shall be adjudged the winner. Refer to Rule 10.14 (Ties).
- (g) In the event a contestant inadvertently receives a speed higher, or a rope length shorter, than the intended pass, the skier shall be given the option of receiving credit for the actual score, accepting credit for the originally requested speed or rope length (assuming a perfect pass) or taking a reride with score protected.
- (h) In the event a contestant inadvertently receives a speed slower or a rope length longer than the intended pass, the skier shall be given the option of opting up (see Rule 10.10(b)(1)) to any pass which follows the intended pass (assuming the pass taken was perfect), accepting credit for the actual pass as skied or taking a reride.

10.14 Ties

- (a) A tie shall exist when two or more skiers have the same score, greater than zero, in consecutive points earned at the same boat speed and line length. For situations where two contestants have equal points but at different speeds and/or line lengths, see Rule 10.13(c).
- (b) If a tie exists, there shall be a new drawing for running order. Run-offs shall start by repeating the pass before the one in which the miss occurred, except when the tie occurs at the skiers' minimum starting speed, in which case the starting speed will remain the same.
- (c) If another tie results, the pass at which the original miss occurred shall be used with a new drawing for order. If a tie still exists, it will be declared a tie.

- (d) Ties shall be run off for the first five places at Regionals and Nationals and the first three places in all other tournaments.
- (e) A two-way tie for second place would eliminate third place, while a three-way tie for second place would eliminate third and fourth places, etc.
- (f) Ties in multi-round tournaments shall be determined as follows: Highest single round total; if a tie still exists, the next highest single round total; etc.

10.15 Damaged Equipment

If a skier notices that his equipment is damaged after a handle throw, a run that leads to a reride, or a completed pass, but prior to the boat starting for the next pass, the event judges may grant him, upon immediate request, three minutes to repair or change the damaged equipment. The three-minute period should start upon the request being granted by the judges. If the skier is not ready to ski at the end of the three-minute period, he shall not be allowed to continue in that round. If this occurs in the case of a mandatory reride, the pass that brought about the reride shall be scored zero. If this occurs in the case of an optional reride, the skier will be credited with the score obtained in the run that brought about the reride.

10.16 Slalom Equipment and Definitions

- (a) Slalom Judging Area: An elevated observation point that provides an unobstructed view of the slalom course, at least 3 meters (10') above the water, shall be provided. More than one such observation point is permissible and desirable. At least two, on opposite sides of the course, are required for Record Capability tournaments and recommended for all other tournaments. If an observation point is located more than 100 feet back from the course centerline, it is recommended that it be elevated approximately ten percent above the water (one foot in height for each ten feet back from the course centerline). It is also recommended that each observation point be placed along a line extending at a 44-degree angle from the center of the entrance gate at that end of the course. See also Rule 10.08(b) for an optional method of judging slalom.

In Class C tournaments and below, if no slalom towers are used, the judges shall be stationed with the best possible view of the course.

- (b) Buoys: For specifications see Rule 8.09.
 - (1) Skier buoys and the end gate buoys shall be bright red or orange.
 - (2) The interior boat guide buoys shall be bright yellow, except that the 55m alignment buoys outside the course on either end shall be of a contrasting color (green is recommended).

(3) For Record Capability tournaments, buoys must either be individually anchored to the bottom or suspended on cross-ways lines anchored on opposite sides of the course. Floating "cable" courses which are anchored solely at the ends of a centerline cable are not permitted for Record Capability tournaments.

(c) Tow lines used for the Slalom event must conform to Rule 8.04 and the Tow Lines Dimension Chart in the Appendix and be supplied with colored loops or sections in the following sequence:

Section	Color
23.00-meter to 18.25-meter	neutral
18.25-meter to 16.00-meter	red
16.00-meter to 14.25-meter	orange
14.25-meter to 13.00-meter	yellow
13.00-meter to 12.00-meter	green
12.00-meter to 11.25-meter	blue
11.25-meter to 10.75-meter	violet (blue/white)
10.75-meter to 10.25-meter	neutral
10.25-meter to 9.75-meter	pink
9.75-meter to 9.50-meter	black
9.50-meter to 9.25-meter	red
9.25-meter to end	neutral

In the event any shortening loops are not installed, the tow line shall be of a neutral color from the final shortening loop to the handle end of the rope.

At the option of the Tournament Committee for Class E tournaments and below, tow lines without shortening loops may be provided and used at the request of the skier for 23.00 meter passes.

- (d) Skier-Furnished Slalom Handle: The contestant may furnish his own handle, for which he is entirely responsible, with an attaching loop to attach to the tournament line, and which must comply with the handle section dimensions in the Appendix. The contestant's handle may be of any material. For Class E tournaments personal handles shall be measured by the dock starter immediately before the skier skis.
- (e) A slalom recoil tube shall be installed on the tow rope in all sanctioned tournaments, except that the Boys 1 and 2/Girls 1 and 2 divisions may be exempted from this requirement.
- (f) Slalom ropes must use a shock tube that is a minimum of 60cm and a maximum of 120cm (approximately 2' to 4').

10.17 Tolerances

The accuracy of all speeds shall be determined by the tables which appear in the Appendix of the Rule Book. The measured times through the segments of the timing course must fall within the tolerances listed in the appropriate columns of these tables.

- (a) Class N Tournaments or Below: The Wide Tolerance ABT Chart in the Appendix may be used.
- (b) Class C and Record Capability Tournaments: The Standard Tolerance ABT Chart in the Appendix shall be used for all skiers and all speeds at class C, E, L, or R tournaments.

RULE 11 - TRICKS

11.01 General

Each contestant shall be allowed two 20-second passes through the trick course (except as provided in Rule 11.03), during which he may perform as many tricks as he can.

11.02 Trick Course

Two sets of buoys approximately 230 meters apart shall establish the approximate area of the beginning of the trick pass from each direction (see Official Trick Course in the appendix) and be configured as an entry gate. The boat shall pass through the entry gate. The end of the pass shall be signified by the 20-second time interval only.

11.03 Trick Pass

Positioning tricks at the start of a pass must be done before the entrance gate.

(a) After passing the approximate position of the entry gates the beginning of the trick pass shall begin:

- (1) For a surface trick, at the first discernable rotation of the ski from the tracking direction (or position).
- (2) For a wake trick, at the earliest of the following to occur:
 - (i) At the first discernable rotation of the ski from the tracking direction (or position) as the skier approaches the wake, or;

(ii) When the ski under the binding of the leading foot leaves the water surface no longer supporting the weight of the skier, or;

(iii) When the binding of the leading foot crosses the crest of the wake.

(3) ***It is the skier's responsibility to start their pass within 15 meters after the entry gate buoys. Re-rides will not be granted for reasons caused by a skier's late start.***

(b) The trick pass shall end when:

(1) Twenty seconds have elapsed from the beginning of the pass, which time shall be marked by sounding a loud audible device; or

(2) The skier falls in the course; or

(3) Three minutes have elapsed, including any time to repair or replace equipment, from the time the skier fell; or

(4) The skier falls twice while practicing.

When using Video Based Frame Counting the last completed trick shall be defined as a skier regaining skiing position on such trick including the skier's weight being supported by the ski on or before the final frame as indicated by spray under the leading binding of the ski.

11.04 Falls

(a) Definition: See Rule 8.06.

(b) The skier is allowed one practice fall without penalty. If a second fall occurs before the start of the first pass, the skier shall not be permitted either pass. A fall at the conclusion of the first pass after the audible device has sounded shall not be considered a fall while practicing, if it is apparent that the fall resulted from a trick the skier was attempting to perform in the first pass. If a second fall occurs before the start of the second pass, the contestant shall not be permitted the second pass.

(c) The stopping of the boat at the skier's request to adjust line length or to pick up or drop a ski will not be scored as a fall.

(d) If the skier is granted three minutes for equipment repair in the event of a fall, in accordance with rule 11.15, then the skier shall receive no further passes if he is not on his skis within three minutes from the time the towboat returns to pick him up.

(e) A handle throw without cause, as decided by a majority of the event judges, is considered a fall while practicing.

11.05 Boat Selection

The skier shall be allowed his choice of the towboat types officially used by the tournament. The use of more than one boat for the skier's two passes is prohibited.

11.06 Boat Speed

The skier shall tell the boat driver what speed he desires on each pass, and/or he may use the preparation time to set the speed up to 50m before entering the course. The skier is allowed to request a speed change after the 50m point, including any time during the run itself, but by doing so must accept the speed given without the right to request a reride for incorrect speed.

The skier must be given the speed setting he asks for before starting the run. If the wrong speed setting is given then that is a reason for a reride provided the skier does not subsequently change the speed.

11.07 Boat Path

The boat shall follow, as closely as possible, the path specified by the judges for the event, such path to include the preparation time before each pass. The second pass shall be in the opposite direction. The boat must make a reasonably straight path through the course. If the skier falls during or at the end of the first pass he will receive a maximum of 30 seconds in which to be ready to be taken by the boat for his second pass. At the skier's option, if he did not fall in his first pass, the boat may stop between passes for a maximum of 45 seconds. In each case the time shall start when the boat gets to the skier. In each case the skier is allowed to change equipment but must be in the water ready to go within the appropriate time frame or he loses the right to his second pass.

For Class C tournaments and below, and at the discretion of the Regional Executive Vice President, both trick passes may be run in the same direction if the site is not suitable for running them in opposite directions.

11.08 Officials

- (a) Shore Judges: There shall be five judges responsible for independently deciding the following:
- (1) Judgments regarding Rules 7, 11.03, 11.04, and 11.12.
 - (2) Deciding with respect to each trick if it was performed according to the rules for that trick.
 - (3) Deciding if a trick is started after the beginning or completed before the end of the pass.
 - (4) Deciding if a fall or handle throw has occurred. (Rules 11.04 and 11.11)

(5) Deciding if a reride is to be given when requested by a skier.

When immediate video review is available, or in Class C tournaments and below, three judges rather than five may be used to score Tricks at the option of the Chief Judge, however, five are still recommended. One immediate video playback may be permitted on each pass (see Rule 11.20).

- (b) Boat Judge: An additional judge shall ride in the boat. He shall check speeds, observe the boat path and stop the boat in the event of a dangerous condition. He shall be authorized to grant rerides, at the skier's option, for deviations in boat speeds and path as governed by Rules 7.01, 11.06 and 11.07. The Chief Judge may designate the boat driver as the boat judge in the event that a TV camera is operated from the boat.
- (c) Official Timer: There shall be a timer on shore approximately in the center of the course. Alternatively, there may be a timer stationed at each end of the trick course with devices which actuate a timing device located approximately in the center of the course. Where an automatic timing device is available which can select the median of five or three separate triggering signals, the event judges may collectively serve as the official timer.
- (d) Backup Timer: A backup timer, with audible signal, must be provided.

In Class C tournaments and below, the backup timer and device for the audible signal may be eliminated at the option of the Chief Judge.

In Class I and N tournaments, at the option of the Chief Judge, the timer on shore may be eliminated, in which case the boat judge shall become the timer, start the stop watch and then sound the audible device at the end of the pass. If there is no audible device available, the Chief Judge may have the boat judge signal the start and end of the pass with a flag.

- (e) Video-Based Frame-Counting Device Operators: When using this method, two judges (minimum rating of one Regular and one Assistant for Class E or two Assistants for Class C) may replace the official timer and backup timer as defined above. The two judges must agree on the starting frame and shall make a determination of the last trick completed in time. If these two judges disagree, the Chief Judge (or his designee) will resolve the disagreement. The shore judges should not be permitted to observe the display of the video based frame counting device while the timing determination is being made by the timing officials.

11.09 Timing

- (a) At the start of the trick pass, the timer shall start his timing device with an audible sound that can be heard in the event judges' tower locations. At the end of 20 seconds, he shall sound his audible device, unless the skier falls within approximately the first 10 seconds. In the event the official timer or device fails to operate, the backup timer and device shall apply.

- (b) An automatic timer must be used for Record Capability Tricks events. An automatic timer that is accurate to within $\pm .10$ seconds in 20 seconds may be used in Tricks events at a Class C tournament or below. Alternatively, a video-based frame-counting device that has been approved by the Technical Committee may be used.
- (c) In the event both timing devices should malfunction and the time is missed, refer to Rules 11.10(d) and 11.20(c).

11.10 Rerides

- (a) Unfair Conditions: See Rules 7.01, 7.02 and 7.03.
- (b) Boat Speed: A reride shall be granted if the boat judge or the boat driver observes the boat speed to vary by more than $\pm .8$ kph (.5 mph).
- (c) Boat Path: A reride shall be granted if the towboat does not follow the boat path established for the tournament (Rule 11.07).
- (d) Timing Devices: In the event both timing devices should malfunction and the time is missed (or in the judgment of the majority of the event judges the time was incorrect), the judges, under the supervision of the Chief Judge, will determine the time from the official video tape provided the course entry buoys appear on the tape or a majority of the judges rule that the skier was in the course at the start of the run. If neither occurs, a reride is mandatory.
- (e) Procedure:
 - (1) If a reride is granted, the reride shall be taken immediately. The reride shall then be given in the original direction through the course.
 - (2) If more than one pass in any run is disallowed for any reason, the skier shall have the option of requesting a five-minute rest before completing the run. Also see Rule 7.02.
 - (3) If a skier receives less than 20 seconds, he shall be granted the option of a reride only on the pass affected. If the skier receives more than 20 seconds, a reride is mandatory.
 - (4) When weather, tournament-supplied equipment, or some other reason not the fault of the skier causes a delay of more than ten minutes between trick passes, the skier shall be allowed an unscored warm up pass, in the opposite direction of the scoring pass to be taken, with a protected score on the first pass already completed. However, the Chief Judge, with the approval of the majority of the Appointed Judges, may deny this option if there is reason to believe that further delays will preclude finishing the tournament in a timely manner or otherwise work to the disadvantage of the remaining skiers.

11.11 Handle Throws

A contestant may refuse to enter the official trick course on either pass by throwing the handle in the air or by being released by the quick release operator by means of a prearranged signal before passing the yellow start buoy. He shall not be penalized for doing so provided the refusal was for a reason acceptable to a majority of the event judges. The skier must be ready to ski immediately upon the boat's return. Should the skier not be ready, the skier will lose one pass. If the skier's refusal is accepted, the boat must repeat the regular path and once again head for the trick course. A handle throw without cause will be considered a fall while practicing. See Rule 11.15 regarding damaged equipment.

11.12 Trick Descriptions Credit and Point Values

- (a) Except in the case of an attempted side slide (see Rule 11.12(i)), a trick is any activity that occurs between two hesitations. Hesitations are defined as the complete stopping of the ski(s) and not the body motion of the skier.
- (b) To receive credit for any trick, the skier must remain in or return to skiing position.
- (c) Only tricks listed in the rules will be scored in a tournament.
- (d) Credit may be received for performance of only one trick and the associated reverse, if any, on one ski, and one trick and the associated reverse, if any, on two skis under each number listed. If a trick skier performs two tricks under the same number, the higher scoring trick should be credited regardless of which is performed first. Tricks may be repeated, but a repeated trick scores zero unless the judges ruled that the first attempt or attempts were unsuccessful.
- (e) A wake turn is a trick performed in mid-air while crossing the crest of the wake. A wake turn not executed in mid-air and across the crest of the wake scores zero.
- (f) All reverse turns must immediately follow the basic turn in the same pass; however, any 180-degree turn is allowed between two such turns. The reverse shall not be disallowed simply because it follows an attempted multiple turn trick that is ruled not continuous, or if the basic trick is a repeated trick. Reverse turns under Trick Number 5 are limited to 360 degrees but may follow a 360-degree, 540-degree or 720-degree turn. Reverse tricks under Trick Number 12 are limited to 540 degrees, but may follow a 540-degree or 720-degree turn.
- (g) There must be no stopping in the turning of the skis in a continuous turn.
- (h) Stepmover line tricks are credited only when the free foot touches the ski or water (except for the toehold stepover), or lifted ski touches the water. The skier may not put his leg or lifted ski across or on top of the line, the handle or either arm until he begins to execute the turn. The stepover and turn actions must be simultaneous. Immediately on completion of a FB stepover

turn, the skier must have at least one arm between his legs holding the handle, except for the toehold stepover. It is not required that the free foot or ski touch the water prior to the execution of a stepover turn. A stepover turn not performed according to the rules scores zero. Toehold stepover tricks must be a simultaneous action. The towing foot may not touch the water during execution of the stepover portion of the trick. The touching of the towing foot in the water immediately prior to or during the rotation of the ski while attempting a stepover trick will result in no credit for the trick. However, if the towing foot touches the water after all rotation has been completed, credit will be given. (Also see Interpretations)

- (i) A Side Slide includes a 90-degree turn from skiing position and a return to skiing position in the original direction. In order for a Side Slide to be a creditable trick, the skier must hesitate before commencing the trick, turn 90 degrees to either side, stop, slide two meters, return to the starting position, and stop. To perform the reverse, the skier must turn 90 degrees in the opposite direction, stop, slide two meters, return to the starting position, and hesitate again.
- (j) A Wake Stepover 360 consists of a 180-degree stepover and a 180-degree turn combined, in either order, all done in the air off the wake in a continuous turn. A Wake Stepover 540 consists of a 180-degree stepover and a 360-degree turn combined, in either order, or a 180-degree stepover preceded and followed by a 180-degree turn combined, all done in the air off the wake in a continuous turn. A Wake Double Stepover 540 consists of a 180-degree stepover and a wake stepover 360 combined, in either order, all done in the air off the wake in a continuous turn. The stepover portion of the turn must conform to all of the rules governing stepovers as noted in Rule 11.12(h).
- (k) In ski line tricks, both feet must be on the ski and pass over the line while in midair. The feet may pass over the line at any point during the execution of the turn. The line must be out of the water during the execution of the turn. This does not include the inadvertent hitting of the rooster tail near the boat.
- (l) Trick skiers may use only one line. Helper lines are prohibited.
- (m) A toe turn is the execution of a trick with the skier being towed exclusively by one foot, and upon the completion of the trick, supported by one ski.
- (n) Once the skier has put the toe strap on his foot, any trick performed in which the foot in the strap intentionally touches the ski during the setup or execution of the trick shall not be scored.
- (o) For wake flips with body rotation, the body rotation must be done simultaneously with the flip, not before or after. The BFLB is not considered a 180-degree turn for purposes of reverse turns as in Rule 11.12(f). Additionally, for the BFLB, the reverse must land in the opposite wrap or turn in the opposite direction. Also, specifically for the BFLB, the stepover portion of the trick must be done simultaneously with the flip and the body rotation.

To receive credit for any wake flip, it is required that both feet be higher than the head and in approximately the same vertical plane at some point during the execution of the trick. A front wake flip shall be defined as a forward somersault done in the air off the wake, in which the tail of the ski passes up and over the head as the head goes down and forward. The rotation must be in the direction of travel.

The reverse BFL is defined as a BFL leading with the opposite shoulder and traveling in the opposite direction (right to left vs. left to right) from the original BFL immediately preceding it.

11.13 Scoring

- (a) The scorer shall receive the judges' individual tabulations and, in the event of a discrepancy, shall decide the tricks to be scored on the basis of a simple majority. If five judges are calling the event, then three judges must give credit for the trick to be scored. Where three judges are calling the event, then two judges must give credit. The official score and placement in the event shall be determined on the basis of the total points for credited tricks performed in both passes. Score values for individual tricks are shown in the Official Trick Point Value Table in the Appendix.
- (b) A trick not completed before the end of the pass shall not be scored. If a contestant's pass is concluded during the execution of a multiple-turn trick, the portion of the trick, whether continuous or not, completed before the conclusion of the pass shall not be scored.
- (c) A trick completed before the end of the pass shall not be scored if the skier ultimately falls as a result of that trick, even if the fall is after the conclusion of the pass.
- (d) Only tricks listed in the rules will be scored in a tournament.
- (e) In the case of a multiple turn trick where the judges disagree, the contestant's score shall be based on the highest number of turns credited by the majority of the event judges.

11.14 Ties

- (a) In the event of a tie, the highest scoring single pass shall determine the winner. If a tie still exists, there shall be a new drawing for order and each tying contestant shall be allowed one pass through the trick course until the tie is broken.
- (b) Ties shall be run off for the first five places at Regionals and Nationals and the first three places in all other tournaments.

- (c) A two-way tie for second place would eliminate third place, while a three-way tie for second place would eliminate third and fourth places.
- (d) Ties in tricks in multi-round tournaments shall be determined by the highest single round. If a tie still exists, the next highest single round, etc. If the tie still exists after all rounds, then the highest single pass, the next highest single pass, etc., shall be used to determine the winner.

11.15 Damaged Equipment

If a skier notices that his equipment is damaged after a handle throw, a pass that leads to a reride or a completed pass the event judges may grant him, upon immediate request, three minutes to repair or change the damaged equipment. The three-minute period should start upon the request being granted by the judges. If the skier is not ready to ski at the end of the three-minute period, he shall not be allowed to continue in that round.

11.16 Tricking Equipment and Definitions

- (a) Trick Judging Area: An elevated observation area that provides an unobstructed view of the trick course, at least 3 meters (10') above the water, shall be provided. If an observation point is located more than 30 meters (100') from the boat path, it is recommended that the tower be elevated approximately ten percent above the water (one foot in height for each ten feet back from the boat path). Alternatively, a live video feed from the boat transmitted to a panel of judges may be used.

In Class C tournaments and below, the requirement that an observation point be elevated may be waived, although it is not recommended.

- (b) Quick-Release Operator: A skier will be allowed the option of a person of his choice, excluding the official boat judge or driver, to act as a quick-release operator. This person will be considered a part of the skier's equipment and be subject to Rule 7.07(a).
- (c) Trick Release: If used, the trick release shall normally be skier-supplied equipment. However, a skier may accept a tournament-supplied release mechanism. In either case, the skier is fully responsible for any release or malfunction of the device, and no request for a reride will be granted for premature or accidental release. A rope trick release mechanism up to 60cm (24") may be used (see Rule 12.05(c)). (Also see Interpretations)
- (d) Buoys: For specifications see Rule 8.09.

11.17 Speed Calibration

Times for speedometer calibration at trick speeds are for the speed indicated from the slalom course entry gates to the third buoy (109 meters). See Appendix.

11.18 Disqualification

The skier-supplied release person would subject the skier to disqualification in the event he interferes vocally or physically with the duties of the boat driver or the boat judge. (Also see Rules 7.07(a) & (b) and Interpretations).

11.19 Communication Between Passes

Skiers in the Tricks event, or other persons, shall not communicate with the judges between passes for the purpose of determining whether a trick or tricks attempted in the first pass were scored.

11.20 Video Tape

The Tricks event shall be recorded at all Record Capability tournaments and whenever else possible by a video tape camera from a suitable shore judging position. If more than one video camera is used, the Chief Judge shall declare one as official prior to the start of the event. (See Rules 11.08(a) and (e))

The video recording may only be shown as an aid to the event judges under the following circumstances:

- (a) At the request of the Chief Judge, if it is not possible for the scorers to obtain a majority decision as to the trick or tricks performed.
- (b) At the request of the Chief Judge, if it is not possible for the scorers to obtain a majority decision as to whether or not credit is to be given for a trick.
- (c) At the request of an event judge or the Chief Scorer, in circumstances which the Chief Judge regards as exceptional, the event judges may review the tapes. This request should not be granted if the intention is to change a judge's decision on credit or no credit for the trick.
- (d) At the request of a majority of the event judges to determine the time for the pass (see Rule 11.10(d)).
- (e) For all trick runs over 10,000 points for men or over 7,000 points for women, any time there is a 3-2 split on the last trick in time, a designated, qualified judge shall be appointed by the Chief Judge to review the video. If the designated person does not agree with the decision, it will then be reviewed by the Chief Judge. If both the video reviewer and the Chief Judge agree, their decision will stand; otherwise the event judges will have to review the video.
- (f) In circumstances which the Chief Judge regards as exceptional, the Chief Judge may review the tape and ask the Event Judges to look at the run again so that the correct score may be established.
- (g) At the request of an event judge (and approved by the Chief Judge) the video may be reviewed to establish credit or no credit of a trick or tricks,

provided that the judge(s) states which trick(s) he wishes to review. It is not the intention to review the entire run.

RULE 12 - SAFETY REQUIREMENTS

12.01 General

No skier or official shall be allowed to participate if, in the opinions of the Safety Director and Chief Judge, the individual is under the influence of alcohol, drugs, or any other mind altering substance, or if his participation would be a danger to himself or others. During the competition, the Safety Director may at any time request that the Chief Judge halt the tournament in regard to any skier's actions or condition.

12.02 Safety Responsibilities

When applying for sanctioning of a tournament, the sponsoring affiliate shall appoint a rated Safety Director. The Safety Director may appoint such assistants as appear necessary and shall be responsible for the safe condition of all equipment and facilities, and operation of the tournament as referenced in the Official Tournament Safety Manual. He shall have the authority to take whatever action is necessary, including stopping the tournament, whenever he observes a condition he believes unsafe. The Chief Judge may overrule any contemplated action or decision of the Safety Director.

12.03 Waiving Disqualification Time Periods

Should the Safety Director stop a tournament for any reason, disqualification time periods (Rules 2.06, 7.02, 9.10, 10.10, and 11.10) shall not run so long as the tournament is stopped.

12.04 Safety Requirements

Skis must be safe. There must be no unnecessary sharp or abrasive (to the touch) parts or other attachments to the ski which would possibly inflict injury to the skier should he come in contact with the ski in a fall.

12.05 Personal Protective Equipment

- (a) Flotation Devices: Flotation devices shall be of non-inflatable design, meeting the following specifications:
 - (1) They must be of a smooth, soft material not likely to cause injury in a fall.
 - (2) They must be fastened in such a manner that they are unlikely to be torn loose, so as to render them useless in a hard fall.
 - (3) They must float the skier.

- (4) They must be constructed so as to provide adequate protection from impact damage to the ribs and internal organs. (A life belt shall not be considered adequate protection in this respect.)

All contestants in Slalom and Jumping events must wear a Coast Guard-approved Type III PFD. At the skier's own personal risk, he may wear a neoprene, nylon (or similar material) covered suit or vest specifically designed by a manufacturer for that purpose. In every instance, it must be capable of floating the skier.

- (b) Protective Head Gear: Use of protective head gear in the Jumping event is mandatory. Protective head gear is defined as an article of apparel whose manufacture and use is solely for the purpose of protecting the head from injury. It is recommended that such head gear be constructed of high-impact material, have a three-point chin strap suspension, be non-bucketing and be of good fit.
- (c) In the trick event, the tow rope will be attached directly to the tow pylon or supplied trick release. Manipulation of the tow rope by the release person during the performance of tricks is prohibited.

12.06 Safety Boat

At least one (two are recommended) safety boat(s) shall be used during all events unless a majority of the Appointed Judges and the Safety Director agree that this is not necessary, in which case safety people will be positioned on the shore. The suggested positioning of the boat or safety people is:

- (a) Slalom Events: Operating outside of the course between plane of Number 2 and Number 5 skier buoys.
- (b) Jumping Events: Operating on the opposite side of the ramp, outside of the jump course buoys, facing the skier's anticipated point of landing.
- (c) Tricks Events: Operating outside of the course buoys, facing the skier during a pass.

12.07 Safety Personnel

The safety boat rider and shore swimmer(s) shall wear Coast Guard-approved life jackets which are fastened at all times.

12.08 Safety Director's Report and Checklist

For the Chief Judge to receive credit for the tournament, the Safety Director's Report and Safety Director's Checklist must be completed, signed and returned with the Master Scorebook, even if no injuries occurred.

12.09 Drivers

No driver of a towboat or safety boat shall pick up a ski, skier, or rope from the water with the ignition on.

12.10 Smoking

Smoking is not allowed at any time in any official tournament boat (either towboats or safety boats).

RULE 13 - OPTIONAL TOURNAMENT FORMATS

13.01 Multi-Round Tournaments

At Record Capability tournaments and below, the sponsoring club may elect, with the express approval of the Regional Executive Vice President, to hold a multi-round type tournament. Such a tournament shall conform to the following rules, in lieu of the related rules for events, overall scoring, and contestant order:

- (a) The tournament may consist of either two or three rounds of competition in each event scheduled. The announcement must state the number of rounds. Tournaments shall be limited to a maximum of three rounds of any one event on days specified in Rule 1.09, except as provided for in 13.02(a).
- (b) Subsequent rounds may be cut to a specified number of competitors based on the contestants' scores in the round(s) preceding the cut. The announcement must state the number of contestants allowed in the rounds after eliminations.
- (c) Each event and overall shall be scored, for purposes of placement, by totaling the scores of all rounds for that contestant as scored under the normal rules, or at the sponsor's option, any combination of rounds may be used. The announcement shall state which of these alternatives is being followed. In regard to scoring any "combination" of rounds, the sponsor can elect to use only one round. Whatever method is used for scoring must be stated in the tournament announcement.
- (d) In a multi-round tournament, no skier shall ski a subsequent round of a given division's event until all previous rounds of that division's event have been completed. It is not mandatory to ski in all rounds to be considered for placement unless the tournament announcement so states.

13.02 Head-to-Head Competition

At Record Capability tournaments and below, with the express approval of the Regional Executive Vice President (cash award requires approval of the Executive Committee), Head-to-Head Competition may be held. A preliminary contest for seeding may be held, or seeding can be based on previous performances, Regional, National, or World Rankings.

- (a) Rounds: The tournament shall consist of no more than three preliminary, non-elimination based rounds and no more than six total rounds. Scores obtained in any round may be included in the ranking list in the same manner that non-elimination based tournaments are included (i.e. generally the best round score).
- (b) Cutting Procedure: Each elimination round shall reduce the field of competitors advancing to a subsequent round by 50%.
- (c) Recommended Procedures:
 - (i) Pairings: The top skiers are paired high score against low score. The high score skier may choose to go out first or second at each pairing. In Slalom, all skiers must start at the same predetermined speed and line length.
 - (ii) General: In each head-to-head pair in slalom, the first skier shall attempt a pass followed by the second skier in an alternating manner until a skier misses or falls. Jumping and Tricks events may be run in the same manner.
 - (iii) Boats: Two alternating boats and drivers may be used in all events. The order shall be determined by the Chief Judge.
- (d) Placement: Placement shall be determined by final round scores only (see Rules 9.13, 10.13, and 11.13). The contestant with the most consecutive points, longest jump or highest score in each head-to-head pair shall be the winner of that pair. The contestant winning the pairing in the final round shall be the winner of the event. The other skier in the final pair shall be considered as the second place skier. Third and fourth place may also be determined in an additional pairing.
- (e) Ties: Ties may be determined on a round-to-round basis only and run off if required under Rules 9.14, 10.14, or 11.14. In Slalom, if the skier going second fails to exceed the score of the skier who went first, the skier who went first wins the round.

RULE 14 - RECORDS

14.01 AWSA Recognition

The AWSA shall recognize records for slalom performances, jump distances, and trick performances for each division listed under Rule 3.02 in tournaments of Record Capability only. (Specific requirements for conducting a Record Capability tournament appear in Rule 15.) Only US Citizens, with USA WS Full Active Membership are eligible to set AWSA records. Citizens of other countries are not eligible to set AWSA records. U.S. skiers may set AWSA records in international

tournaments shown to meet the standards of a tournament of Record Capability. Run-offs of ties are used solely for determining placement, therefore a run-off performance is not eligible for consideration as a record.

14.02 Performance Requirements

For any division, the longest jump distance, highest slalom score, or highest trick score in a round of a tournament of Record Capability shall be considered for a record if it equals or exceeds the official record performed before that round of the tournament. A skier competing in the Open Division may have his performance recognized as a record for his respective age division, provided the performance is accomplished under conditions consistent with the requirements for that age division. If more than one performance in a round of a tournament equals or exceeds the official record performed before that round of the tournament, all such performances shall be submitted for consideration, although only the highest of those which satisfies the review requirements shall be recognized. Open Division jump records shall be listed in meters and must exceed the existing record by at least 10 centimeters. Eligible performances which equal an existing record (other than by a current holder of that record) may be recognized, whereupon that skier would become co-holder of the record.

Whenever a new age division is created, or a change is made in the age ranges for an existing division, or a change is made in the performance conditions for an event for an age division, a benchmark score shall be established for that event, unless that benchmark would be lower than the existing record. This benchmark shall be the highest score achieved at the previous National Championships in that event by a skier eligible for the affected division.

When a benchmark score is used to establish a basis for setting records, it shall not be considered as the event record. Only scores that equal or exceed the benchmark shall be considered for a record.

Where a benchmark cannot be established by the highest score at the previous National Championships, or in other circumstances where such a benchmark would clearly be inequitable, the benchmark shall then be established jointly by the Skier's Qualification and the Technical Committees.

14.03 Site Specifications

Specifications of equipment, courses, measuring devices and methods shall be set in accordance with the Rule Book and shall be recorded on AWSA Record Forms, to be completed and certified by the Chief Judge and other required officials. Additional requirements specific to Record Capability tournaments (beyond the normal requirements listed throughout this Rule Book) are listed in Rule 15.06.

14.04 Record Forms

Record forms shall be devised in accordance with these rules by the Technical Committee approved by the Board of Directors. All requirements for the record submission and approval process will be set forth in the official application form.

- (a) For a Tricks record to be considered, the official video must be reviewed by the judges. Subsequent to the scoring of an event and the existence of a tentative record, the judges for the event shall review the tape to determine the scoring of the record on the basis of the tape. Any changes in the scoring resulting from this review shall not change the results of the tournament itself (although the provisions of Rule 11.20 may otherwise result in official scoring changes). The video tape (standard size VHS cassette) and the original judges scoring sheets shall accompany the record application.
- (b) For a Slalom record to be considered, video of the boat path is required (see Rule 15.07(d) below) for all passes. The video tape (on standard size VHS cassette) shall accompany the record application.

For Slalom the final two passes on the video tape will be examined by the Technical Chairman or his designee to verify that the boat path is within the following deviation specifications: Maximum deviation of the boat on approach to each buoy/gate is 20 cm (8 inches) toward the side of the skier buoy. The Total Cumulative Deviation (the algebraic sum of the individual deviations) is to be evaluated based on the score for the pass, as follows:

Score	Limit	Score	Limit
0.25 - 1.00	20 cm	3.25 - 4.00	40 cm
1.25 - 2.00	28 cm	4.25 - 5.00	45 cm
2.25 - 3.00	35 cm	5.25 - 6.00	49 cm

- (c) For a Jump record to be considered, when using a video-based jump distance measurement system, the application shall include the survey, a copy of the video (standard size VHS cassette), a gif formatted file of the record jump, a gif file of the video grid box if in the record jump gif any of the buoys are obscured, and all configuration and setup files appropriate for the system being used to allow independent verification.

14.05 Application Procedure

- (a) It shall be the skier's responsibility to promptly notify the Chief Judge, or other event judge, if he believes his performance may qualify as a record.
- (b) It shall be the Chief Judge's responsibility to complete the record application form, with assistance from the Chief Scorer and Technical Controller and other event or appointed officials, as may be required by the Record Form. The completed Record Form and other required materials, as specified in the Record Form, shall be sent by the Chief Judge to the Chairman of the Technical Committee within 21 days of the date of the performance. In addition, the Technical Controller of the tournament shall send notification of the performance to the Chairman of the Technical Committee within 10 days of the performance. After review, the Chairman shall forward recommendations, to the AWSA President for final approval.

RULE 15 - RECORD CAPABILITY TOURNAMENTS

15.01 Tournaments at Which AWSA Records May Be Set

AWSA records may be set at World Championships, National Championships, Record Capability Regional Championships, and other tournaments meeting the standards for Record Capability. There are three classifications of Record Capability tournaments, whose applicability and requirements are summarized in the chart that appears in the Appendix. Class L and R tournaments must meet or exceed the standards of the IWSF Rule Book, and must be sanctioned by the Pan American Region of the IWSF, as well as by USA Water Ski.

- (a) National Championships: The National Championships must meet the qualifications of a tournament with Record Capability, and it shall be the responsibility of the Chief Judge and other Appointed Judges to determine that it does so qualify.
- (b) Regional Championships: The Regional Championships are encouraged to meet the qualifications of Record Capability. It shall be the responsibility of the Regional Council to determine if it wishes to impose these standards on the Regional Tournament and, if imposed, it shall be the responsibility of the Chief Judge and other Appointed Judges to determine that it does so qualify.
- (c) Tournaments with Record Capability: Tournaments with Record Capability shall be specifically sanctioned tournaments meeting standards as detailed below and summarized in the Appendix.
- (d) A tournament sanctioned at one of the three levels of Record Capability may conduct individual events at a lower sanction classification than that of the tournament as a whole. In such cases, the applicable classification code must be indicated in the official scorebook for each skier performance listed.

15.02 Sanction and General Tournament Organization

- (a) The sanction application for a tournament with Record Capability must be submitted directly to USA Water Ski Headquarters no later than **14** days prior to the scheduled start of the tournament. Record Capability tournaments other than National Entry (Class E) must also be sanctioned by the Pan American Region of the IWSF.
- (b) In order to produce a Record Capability tournament, a sponsor must have produced a sanctioned tournament during or since the prior two calendar years.
- (c) Divisions and events to be scheduled shall be at the option of the tournament sponsors and may include any or all of those included in Rule 3.02.
- (d) Exceptions to the rules allowed as under Rule 1.11 are permitted and will be approved in the manner specified in the rules.

- (e) Tournaments may have multiple rounds as permitted by Rule 13.

15.03 Certification of Competition Courses

- (a) The Technical Committee shall devise and publish standards for the certification of competition courses. Such standards shall require that all slalom and jump course buoys and the jump ramp and meter station pivot centers be located by appropriate survey methods. The inter-relationships among these objects shall be derived there from, and must be within the location tolerances shown in the Official Slalom and Jump Course Diagrams in the Appendix.
- (b) The competition slalom and jump courses required for the events scheduled for the tournament must be certified in advance of the tournament by either one of the following two procedures:
 - (1) The slalom course and the jump course shall be surveyed by either a licensed surveyor, acting as such, or by a person independent of the tournament sponsors who satisfies the Chairman of the Technical Committee as to his competence prior to the survey, no more than 90 but no less than 30 days prior to the tournament. The survey and supporting detail shall be forwarded to the Appointed Technical Controller for the tournament at least one week prior to the tournament.
 - (2) Alternatively, the Appointed Technical Controller may certify the courses by his own survey prior to the tournament, and shall attach that survey and its computer analysis showing the actual buoy locations to the Technical Controller's Report from the tournament, along with any adjustments which were made.

15.04 Technical Controller

- (a) Each tournament with Record Capability shall require a rated Technical Controller.
- (b) It shall be the responsibility of the Technical Controller to determine, by methods he believes to be required under the circumstances, that the courses continue to be certified prior to the start of competition. The Technical Controller shall continue to be responsible for the certified condition of the competition courses throughout the tournament and must sign a statement at the conclusion of the tournament that, in his opinion, the courses were entitled to certification throughout the tournament.
- (c) Standards devised by the Technical Committee for the position of Technical Controller, along with a handbook of instructions for his guidance, may be considered a part of this Rule Book.

15.05 Qualifications of Officials

- (a) At Class E tournaments, the Chief Judge shall be a Senior Judge, and may serve as an event judge. The other Appointed Judges shall be either Senior or Regular Judges. The Chief Boat Driver shall be a Senior Driver. The Chief Scorer shall be a Senior Scorer. All chief officials (Chief Judge, Chief Driver, Chief Scorer, Chief Technical Controller and Chief Safety Director) shall be separate individuals.
- (b) Throughout these sections where designations of judges' classifications are used, judges with equivalent ratings certified by a region or federation of the IWSF as determined by the Judge's Committee may be used. (See Rule 6.10.)
- (c) All positions described in the rules as "judges" shall be filled by Senior or Regular Judges. In Class E Jumping events, one of the two shore judges may be an Assistant Judge. In Class E Slalom events, an Assistant Judge may replace one of the two slalom tower judges in each tower when 5 judges are being used. In class E trick events an Assistant Judge or a Regular or Senior Driver may serve as a boat judge. All boat drivers shall be Senior or Regular Drivers. All scorers shall be Senior or Regular Scorers. In Class E Slalom and Jumping events, event scorers may be Assistant Scorers. For Ranking List (Class L) tournaments, the majority of the event judges (3 of 5 in Slalom, 3 of 5 in Tricks, and 2 of 3 in Jumping) must be Senior Judges. For Class R tournaments, which may qualify possible world records, all of the event judges in Slalom (5), Tricks (5), and Jumping (3) must be Senior Judges.
- (d) The following minimum qualifications shall be required of other officials in the Slalom event:

Backup Timer: Assistant Judge. Regular and Senior Drivers may be considered Assistant Judges for purposes of this requirement only.
- (e) The following minimum qualifications shall be required of other officials in the Jumping event:
 - (1) Meter Readers: At least one reader at each station shall be a Senior or Regular Judge. The other reader at each station may be selected from competent assistants available.
 - (2) Masterboard Operators: The computer shall be operated by a person competent at operating a computer, and supervised by a Senior or Regular Judge if not so qualified.
 - (3) Backup Timer: Assistant Judge. (Regular and Senior Drivers may be considered Assistant Judges for purposes of this requirement only.)
- (f) The following minimum qualifications shall be required of other Officials in the Tricks event:
 - (1) Trick Timer: Regular Judge

- (2) Backup Timer: Assistant Judge
- (g) Official's Conflict of Interest: Conflicts of interest, as defined by the following, shall not be permitted in Record Capability or Cash Prize tournaments.
 - (1) An official for an event shall have no conflict of interest with respect to any skier competing in that event. For this purpose "official" shall include boat drivers, event judges, scorers and all secondary positions.
 - (2) At least one-half of the Appointed Judges shall have no conflict of interest with any skier competing in the event. If a conflict of interest exists, the appointed official so affected shall not rule.
 - (3) The appointed officials to the Team Trials must have no conflict of interest with any skier competing in the Trials.
- (h) A conflict of interest shall be regarded as existing if the official is:
 - (1) A member of the immediate family of a contestant, to include lineal descendants and ancestors, brothers, sisters, and spouses of the contestant or any of the above family members.
 - (2) In a position which may give the appearance of a lack of independence. These conflicts shall be determined by the Chief Judge with respect to event officials and by the Appointed Judges with respect to the Chief Judge and other appointed officials.
- (i) Record Capability tournaments shall require a minimum of five Appointed Judges in addition to the Chief Judge.
- (j) IWSF-sanctioned Record Capability tournaments (Class L or R) must include one official certified by the Pan American Region and this may be one of the chief officials.

15.06 Technical Requirements

- (a) For the Tricks event, a manually triggered "automatic-countdown" timing device shall be used. Alternatively, a video-based frame-counting device which has been approved by the Technical Committee may be used.
- (b) When using a three meter system to measure jump, the computing device shall be tested against the benchmarks which appear in the Appendix. (see Rule 9.16(b))
- (c) All trick passes must be videotaped from the boat or from a shore judging position as designated by the Chief Judge and shall be from the same loca-

tion during the entire event. If review is required, each judge will review the tape individually and independently in normal speed only. (see Rules 11.20 and 15.06(a))

(d) Slalom Requirements:

- (1) End-course video shall be recorded in the Slalom event for all passes. A rigidly mounted video camera shall be operated from a point on the centerline on at least one end of the slalom course, adjusted to show all of the boat guides in clear focus and equipped with optical (not digital) magnification of sufficient power to display the far entrance/exit gate occupying at least 1/6th of the full width of the screen (1/3 width or larger is recommended). It is recommended that a radio receiver be placed by the recorder so that all radio transmissions are recorded on the audio track, that the skier's name and speed and/or line length be announced on each pass, and the actual times recorded by the official timing devices also be announced. It is further recommended that a monitor be placed in the judges tower, and that this be observed by an official designated by the Chief Judge for compliance with Rule 10.07 during any critical passes involving potential records. The video tape recordings of non-record passes (on standard size VHS cassette) shall be submitted to the Regions Driver Committee Representative.
 - (2) The average of the six "F" (skier buoy width) dimensions shall not be less than 11.48 meters. See the official Slalom Course Diagram in the Appendix.
 - (3) The judging area on each side of the course shall be located within 44 degrees \pm 3 degrees from the course centerline (rotated clockwise about a point at the center of the entrance gate to the left end of the course as seen from that observation point). If it is not feasible to place the judges' tower at the prescribed angle, a video camera may be mounted at the proper angle and the live signal fed to a monitor in the judges' tower, so that the appropriate event judge(s) can observe the gates. Judgment on the gates will be made by viewing the monitor. The signal will be taped so that review is possible. See also Rule 10.08(b) for an optional method of judging slalom.
- (e) The "Record Tolerances" shall be used in verifying boat times in the Jumping event only when a skier is at the maximum speed for his division. See Rule 9.17 and the tables in the Appendix.

RULE 16 - CASH PRIZE TOURNAMENTS

16.01 General

- (a) Any and all divisions may be scheduled.
- (b) A notice similar in content to the following should be printed on the entry form: "USA Water Ski hereby notifies all officials, water skiers and their guardians that participation as a contestant or official in a water ski show, exhibition, or tournament where awards of money or products are given may adversely affect their amateur standing in any or all sports."
- (c) Organizers should be aware that it may be required that cash prizes be paid directly to the President of the skier's IWSF region or to the skier's national federation. Organizers must agree that upon request of any competitor or national federation this condition will be honored.
- (d) All Chief officials (Chief Judge, Chief Driver, Chief Scorer, Chief Technical Controller, and Chief Safety Director) shall be separate individuals.
- (e) Any AWSA Club organizing a tournament with a cash prize may petition the Executive Committee for permission to conduct the tournament under rules exceptions. This petition, along with the entire rules exception proposal, must be submitted to the Executive Committee at least 21 days before the tournament, and must be acted upon by the Executive Committee within 7 days. Upon written approval the rules exceptions must be included in the tournament announcement, and referenced in mailings to all participants. The AWSA sanction fee will be established by the Executive Committee on an individual basis.

Appendix

Rules Interpretations

General Considerations

Rule 1.02: IWSF class events (L & R) conducted under USAWS sanctioning will be conducted administratively by applying AWSA rules and applying IWSF rules, where different from AWSA, in instances where skiing conditions are affected. The intention is that performances for consideration to be included in world ranking lists or for world records be conducted under conditions identical to events conducted elsewhere in the world (IE a level playing field). Some examples include trick falls before the course and waiver of conditions encountered in jump. Some examples of administrative rules that do not affect skiing conditions, and therefore AWSA rules would apply, include tie breaking rules, tow rope specifications or skier supplied allowances, and starting line lengths. (2004)

Rules 6.08 and 7.06: The results of a day's last event may be posted at the beginning of the next day (except for the final day). In this manner, the Chief Judge can comply with the rules while all those concerned have a fair opportunity to verify their results. (1991)

Rule 6.11 – Judge/Scorer Emeritus: An official with an Emeritus status may serve as a chief official in a Class C or below tournament. (2002)

Rule 7.01 – Unfair Conditions: Should inappropriate use of the "Aqua Gate" result in a setting that the skier did not desire this shall be considered a malfunction of tournament supplied equipment. (2005)

Rule 8.10(f) – Speed Control: If a perceptible malfunction in the speed control occurs during a slalom or jump pass, it is possible (irrespective of the recorded times) that the skier will have received an unfair advantage, and the skier shall be required to take a mandatory reride (2002). (See Rule 10.10(b)(3) interpretation (2003)) The 80# jump switch shall be considered skier supplied equipment. The skier shall accept responsibility for any malfunction including those that produce a bad time. When a bad time resulting from a malfunction occurs the jump shall be scored as a pass. (2005)

Slalom

Rule 10.10(b)(3) – Missed Times (2003)

New rules in the Slalom event can result in "Partial Pass Protected Scores", although only in the event of a timer or speed control system failure or in the cases where a malfunction of certain tournament supplied equipment has occurred.

Examples of some of the circumstances where this concept may be applied would be:

Speed control malfunctions

Dislodging of the magnet causing inappropriate speed control operation or a missed time in the applicable timing segment

Towline breakage or towboat breakdown or running out of gas

In these instances, the official identifies an earlier segment time value which is in tolerance, and protects that much of the score up to that point. The skier may then take a reride with that score protected, or may accept that score and retire at that point. Or, if the pass had been complete, the skier may opt up, with that partial pass score protected also.

A time that is merely slow does **NOT** represent a speed control failure or malfunction of tournament supplied equipment. This provision is **ONLY** to be applied when there is a clear **IRREGULARITY** in the delivered boat speed.

Tricks

Rule 11.12(h) – Toehold Stepmover Tricks: The touching of the towing foot in the water prior to or during the rotation of the ski while attempting a stepover trick will result in no credit for the trick. However, if the towing foot touches the water after all rotation has been completed, credit will be given. (1999)

Rule 11.16(c) - Tournament Supplied Trick Release: If the skier wants to supply his own release but the release on the tournament-supplied towboat cannot be removed, then he is no longer considered responsible for the proper functioning of that release. If it does malfunction, he may ask and be granted a reride. (1992)

Rule 11.18 - Disqualification: The intention of this rule is to assure the duties of the officials are not impeded and to assure fair and equitable conditions for the competitor and his competitors. For example, if the release person acts in an unsportsmanlike manner or in a manner whereby the officials are unable to set path, speed, or conduct their duties, then the skier may be subject to disqualification. Examples of acceptable conduct include communicating with the officials to set speed, path or wake characteristics. Communications with the skier, including coaching, after a fall or in the 30-second sit down, are allowable, provided the communication does not interfere with the officials. (2001)

Rule 11.21 - Declared Trick Lists: This requirement was eliminated in AWSA Tournaments starting in 2003 and by IWSF starting in 2007. However, AWSA tournaments that include IWSF class events may still require a list to be turned in but the list need not be adhered to. The skier shall receive credit for the tricks performed that a majority of the judges credit.

2009 IWSF/AWSA Rules Differences

These are the most significant differences between the current IWSF and AWSA rules as they apply to the running of the actual events of Slalom, Tricks, and Jumping, as opposed to the administration of a tournament. Refer to AWSA Rule 1.01 for the use of AWSA and IWSF rules in Class L and R tournaments.

A. General:

1. **Schedule Changes** (IWSF 2.04/AWSA 2.03): AWSA Rules stipulate that all affected skiers or their representatives must be directly notified of any changes. IWSF requires similar notification but through posting alone.
2. **Use of Flags** (IWSF 8.05/AWSA 9.10(d) and 10.10(d) and (e)): IWSF Rules stipulate the use of red for mandatory and green for optional rerides. AWSA Rules no longer require flags for Slalom rerides.
3. **Ties and Placement Resolution** (IWSF 13.13, 14.12 and 15.18/AWSA 9.13(b), 9.14, 10.13(g), 10.14 and 11.14): If two or more skiers are tied for first after their rides, IWSF Rules require a run-off. AWSA Rules have additional tie breaking provisions in Slalom and Tricks (in Slalom, the faster speed or shortest rope length and, in Tricks, the highest single pass). For subsequent medal placements, IWSF Rules revert first back to the preliminary round score before going to a run-off, while AWSA Rules follow the same guidelines as for first place ties. The actual run-off procedures are the same for Tricks and Jumping. See below for Slalom.
4. **Unfair Conditions** (IWSF 8.02/AWSA 7.01): AWSA Rules protect scores on an optional reride in the case of a malfunction of tournament-supplied equipment. IWSF Rules do not.
5. **Speed Control** (IWSF 10.07/AWSA 8.10): IWSF requires that a written record of speed control settings and changes thereto be maintained. IWSF requires the use of a second display AWSA contains no such provisions.

B. Slalom:

1. **Rope Length** (IWSF Rule 14.07/AWSA Rule 10.06(c)): IWSF Rules specify rope lengths starting with an 18.25m rope; AWSA Rules specify rope lengths starting with a 23m rope.
2. **Slalom Ties** (IWSF Rule 14.12/AWSA Rules 10.13(g) and 10.14):
 - a. IWSF Rules permit as many run-offs as necessary to resolve a tie. AWSA Rules set a limit of two after which the official result is recorded as a tie.

- b. All IWSF run-offs are at the last completed speed or line length. AWSA Rules stipulate that, on the second and final attempt, the tie will be run off at the pass in which the miss occurred.
 - c. If the skiers start at different line lengths and do not complete the first pass, but score the same number of buoys on that first pass, IWSF Rules require that the skiers continue the run-off, considering that result a tie. AWSA Rules award first place to the skier with the higher speed or shorter rope length without proceeding to a second and final run-off.
3. **Starting Rope Lengths** (IWSF 14.07/AWSA 10.06(d)(2)): AWSA Rules allow the skier to start at any line length below maximum speed. IWSF Rules do not. However, an interpretation from IWSF has indicated this is permissible. Both permit the optional skipping of passes in initial rides and the run-offs.
 4. **Slalom Handles** (IWSF Homologation Guidelines 1(e)/AWSA 10.16(d)): IWSF Rules stipulate that personally furnished handles shall be measured at the dock immediately before skiing and remain in the custody of the tournament official. AWSA Rules contain no such requirement.
 5. **Handle Throws & Damaged Equipment** (IWSF 14.15 & 8.04/AWSA 10.11 & 10.15): AWSA Rules no longer imply that slalom is a continuous event and allow handle throws and requests for damaged equipment time-outs between passes. IWSF Rules have no such stipulations but do allow for similar damaged equipment time-outs on passes leading to a re-ride.
 6. **Slow Time and Scoring** (IWSF 14.14/AWSA 10.10(b)(1)): At class C and below, AWSA allows an improvement in score on a slow time, IWSF does not.
 7. **Missed Passes** (IWSF 8.02/AWSA 10.10(b)(3)): If the applicable segment time is missed, IWSF treats this as a failure of tournament supplied equipment and the score is not-protected whereas AWSA treats the time as slow, except that the skier may improve his score, may accept the highest score with a good applicable segment time, or receive an optional reride with a protected score equal to the highest score with a good applicable segment time.
 8. **Scoring** (IWSF 14.07 & 14.11 /AWSA 10.06 & 10.13): IWSF requires the skier to start at maximum speed and 18.25m (unless the event judges determine otherwise), or shorter if the finals, and the skier shall receive additional buoys for the skipped (required or elected) passes. AWSA does not contain these provisions. However, IWSF has issued an interpretation that they do not object to slower starting speeds, however such passes are un-scored under IWSF.

C. Tricks:

1. **Practice Falls** (IWSF 15.02/AWSA 11.04(b)): Under IWSF Rules, no practice falls are allowed. The handle throw rule is the same.

2. **Fake Falls** (IWSF Rule 15.02 [last paragraph]): If a majority of the event judges determine that the skier has fallen deliberately after the end of his (first) 20-second pass, he loses the right to continue the round. This judgment decision is to encourage the skier not to attempt such a fall at all.
3. **Trick Release Use** (IWSF 15.11 /AWSA 11.16(c) and Interpretation): IWSF Rules allow a reride if the tournament-supplied release breaks. AWSA Rules do not.
4. **Declared Trick Lists** (IWSF 15.16): IWSF Rules may require submission of trick lists. AWSA does not. If required to be submitted, neither require adherence to the list to receive credit for tricks performed if a majority of the judges give credit.
5. **Video Review** (IWSF 15.11/AWSA 11): IWSF specifically states that the skier will not be held between passes for any video review. AWSA contains no such provision.
6. **Six Flips** (IWSF 15.17/AWSA – Not Applicable): IWSF limits the number of scored flips to six and AWSA does not. A skier may attempt more than six flips under IWSF but only the highest scoring six will be scored.

D. Jumping:

1. **Helmets** (IWSF 7.09/AWSA 12.05(b)): IWSF Rules state that the skier must wear a suitable helmet without further definition. AWSA Rules stipulate the wearing of protective head gear with a definition of what that is and further recommendations, but recommendations only, and no specifics.
2. **Waived Reride Request** (IWSF 13.01/AWSA 9.10(f)): AWSA Rules state that, once a skier has taken a definite cut toward the ramp, he automatically waives any reride request regarding conditions encountered prior to the start of the timing course. IWSF Rules read that, after the skier passes the 180m buoy, he can no longer request a reride for conditions prior to the buoy unless he has thrown the handle by that time.
3. **Women at .255 ratio** (IWSF 13.01 and 13.02/AWSA 9.16(c)(4)): Under both IWSF and AWSA Rules, women are allowed the option of choosing either a .235 or .255 ramp slope. AWSA Rules further stipulate that only Open Women are allowed the .255 option and only if they can show a certified result from a Record Capability tournament of 40m (132') on a .235 ramp.
4. **Second Segment Timing** (IWSF 13.04/AWSA 9.09): AWSA requires timing of the second segment in all instances. IWSF only requires that the 2nd segment speed does not exceed the division maximum when using their optional (fast second segment) method in cases where the speed is below the division maximum. Additionally, effective May 1, 2008 IWSF requires three-segment

timing *of 52m – 30m – 41m, while AWSA requires reporting 3 segment jump times, although using two segment timing of 82m and 41m as controlling.*

5. **Jump Distances and Outcomes** (IWSF 13.11/AWSA 9.03): IWSF requires the judge offer the skier a reride in the event the distance is not communicated or is miss-communicated to the skier. The reride may or may not be protected as determined by the judges. AWSA requires that the outcome of each jump, including any reride situations, be communicated to the skier, but does not require the judge to offer a reride if there is a failure in this procedure.
6. **Accepting Conditions Prior to the Jump Course** (IWSF 13.01/AWSA 9.10(f)): Under IWSF Rules, once the skier passes 180M (start of course buoy), the skier can no longer request a reride for conditions encountered prior to the 180m buoy. Under AWSA the skier may no longer make the request for a reride for conditions encountered prior to the start of the timing course after the skier makes a definite cut to the ramp. For conditions encountered after these points in the course, the rules are the same in that a skier may request a reride but it is up to the event judges.

Officials Development Program Disciplinary Procedures

(Judges • Scorers • Drivers • Safety Directors • Technical Controllers)

With each step, written approval of two-thirds of the Appointed Judges is required to take action against an official, and this approval must be recorded and included in the report to the appropriate entity as specified below.

First Offense to Be But Not Limited To:

- On-site notification and warning by the Chief Judge with written report of action to committee chair

The record of this offense will be removed from the official's file in one year from the date of infraction provided no further offenses occur.

Second Offense to Be But Not Limited To:

- Letter of reprimand from the entire committee
- Not officiate at the immediate next Regionals or Nationals, or both, after the date of the letter of reprimand, with written report of action to Sport Division President

Providing no further offenses occur, and without removing the record of this offense from the official's file, the time limit on this offense for further discipline will end two years from the date of infraction.

Third Offense To Be But Not Limited To:

- Letter from Sports Division President
- Downgrade mandatory with written report of action to Sport Division Board of Directors

Providing no further offenses occur, and without removing the record of this offense from the official's file, the time limit on this offense for further discipline will end three years from the date of infraction and the official may start work from the beginning on the rating lost.

Fourth Offense To Be But Not Limited To:

- Board of Directors to vote on complete loss of Officials rating

After three years from the date of infraction, the official may start over again with the application process at the Assistant rating level.

All disciplinary procedures and actions must comply with the bylaw articles regarding ineligibility of participation, grievance, and due process. These procedures are not intended for the occasional honest mistake, only for those habitually breaking the rules.

The following are examples of violations, but are not all-inclusive:

- All Officials:**
1. not following the rules in order to enhance skier performance or site reputation by:
 - abusing any tolerance (Rule 1.12, etc.)
 - allowing abuse of any tolerance without reporting it or taking corrective action, if appropriate;
 2. not following the rules after having been notified of the problem;
 3. not following the rules tournament after tournament;
 4. Engaging in verbal or physical abuse of other officials or tournament personnel.
- Judges:**
1. manipulating the timing in tricks to give the skier more or less than 20 seconds
 2. knowing that the speed deviation was more than ½ mph and not granting a reride
- Scorers:**
1. intentionally giving a skier or group of skiers a better or worse score in any event or overall
 2. manipulating the points and credits in scoring tricks to produce more or less points for a skier or group of skiers
- Drivers:**
- Driving to enhance skier performance with:
- consistently slow times during a Slalom event with one or a group of skiers
 - a boat path consistently favoring or disfavoring one or a group of skiers
 - consistently fast times during a Jump event with one or a group of skiers
- Safety Directors:**
- Not following the rules as written in the official AWSA Tournament Safety Manual by:
- not checking skier equipment, the jump ramp or the starting dock
 - not using a safety boat and personnel as prescribed
- Tech. Controllers:**
- Setting up the ski site in violation of the rules to enhance skier performance by:
- setting slalom courses too narrow
 - allowing the use of excessively long slalom towropes
 - allowing timing systems to be operated without prior checking
 - filling out record application forms incorrectly
 - setting up the ramp incorrectly

Tow Line Dimensions

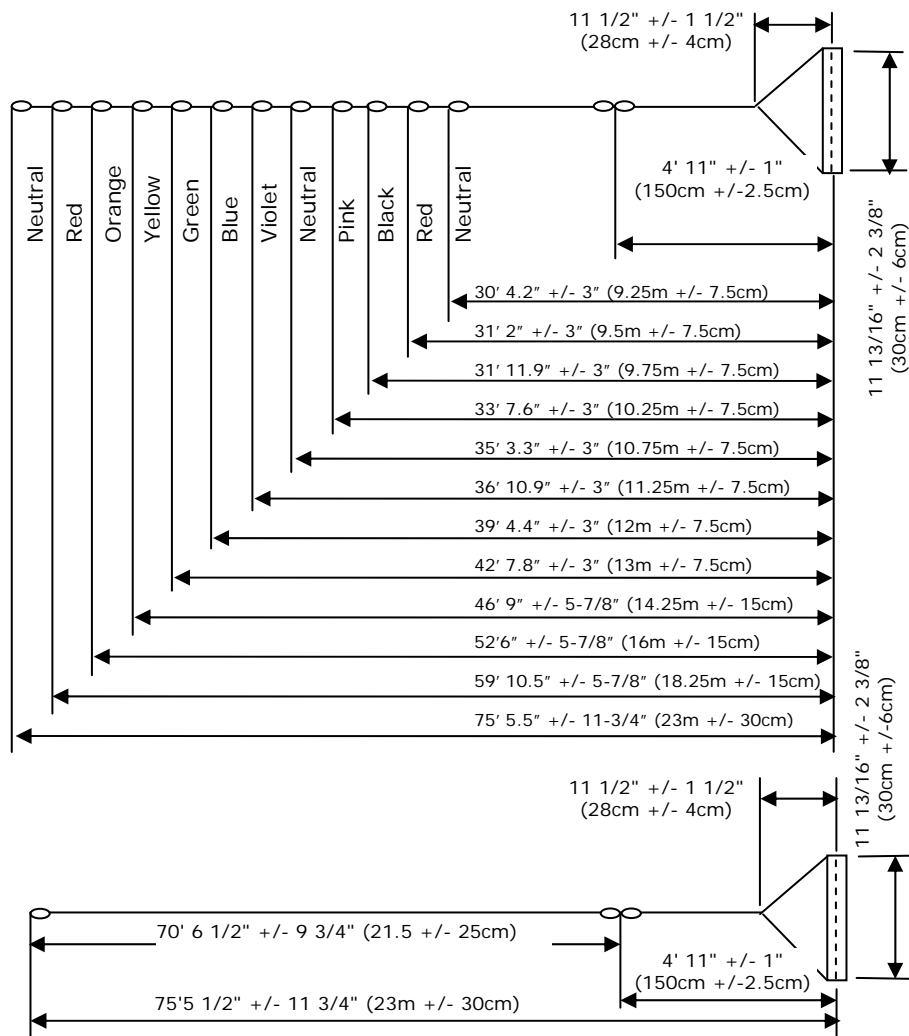

Note: For tournament-supplied handle sections, the bridle length shall be 150 cm \pm 2.5 cm (4'11" \pm 1") the triangular portion of the bridle 28 cm \pm 4 cm (11 1/2" \pm 1 1/2"), and the length of the handle 30cm \pm 6 cm (11-13/16" \pm 2-3/8") (see diagram). For skier-supplied handles in the Slalom and Jumping events, the tolerance on the bridle length shall be +2.5 cm/-10 cm (+1"/-4) with no tolerance on the triangular portion of the bridle.

A Slalom Switch or other appliance may be used to attach the slalom towline to the pylon. When so used, that appliance shall be considered a part of the boat/pylon, may be from 0.47 to 0.51m in length, and with a recommended length of 0.50m. The measurements of ropes used with such appliances shall be 0.50m shorter than the values shown in this table.

Official Slalom Course

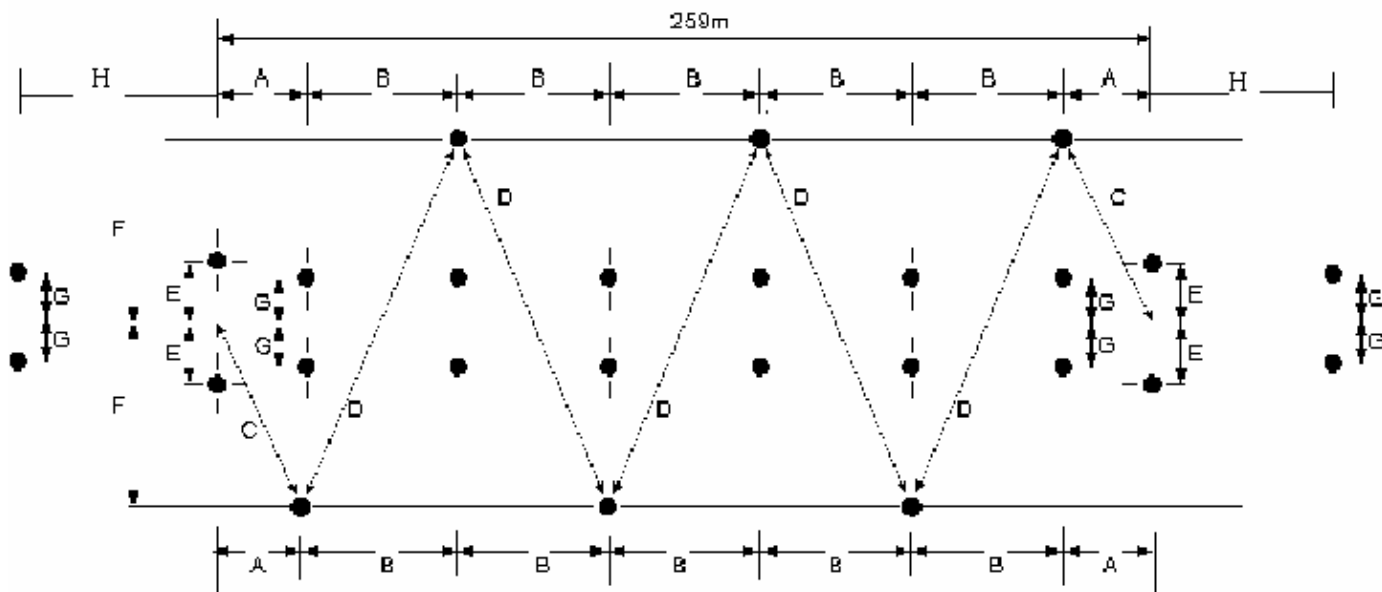

Dim	Metric			English					
	Actual	Minimum	Maximum	Actual		Minimum		Maximum	
OA	259m	258.353m	259.648m	849'	8 ⁷ / ₈ "	847'	7 ³ / ₈ "	851'	10 ³ / ₈ "
A	27m	26.865m	27.135m	88'	7"	88'	5 ⁵ / ₈ "	89'	1 ¹ / ₄ "
B	41m	40.795m	41.205m	134'	6 ¹ / ₈ "	133'	10 ¹ / ₈ "	135'	2 ¹ / ₄ "
C	29.347m	29.2m	29.494m	96'	3 ³ / ₈ "	95'	9 ⁵ / ₈ "	96'	9 ¹ / ₈ "
D	47.011m	46.776m	47.246m	154'	2 ³ / ₄ "	153'	5 ³ / ₈ "	155'	1 ¹ / ₈ "
E	1.25m	1.188m	1.313m	4'	1 ¹ / ₄ "	3'	10 ³ / ₄ "	4'	3 ³ / ₄ "
F	11.5m	11.385m	11.616m	37'	8 ³ / ₄ "	37'	4 ¹ / ₄ "	38'	1 ³ / ₈ "
G	1.15m	1.035m	1.265m	3'	9 ¹ / ₄ "	3'	4 ³ / ₄ "	4'	1 ³ / ₄ "
H	55m	54.725m	55.275m	180'	5 ³ / ₈ "	179'	6 ¹ / ₂ "	181'	4 ¹ / ₄ "
Tolerances (±)									
				¼% on 259m		5% on E			
				½% on A,B,C,D,H		10% on G			
				1% on F					

At all Record Capability tournaments (E,L,R) including Regionals and Nationals, boat path alignment gates consisting of cylindrical buoys (green recommended) of a color contrasting to the official course buoys, and placed outside the official course at a distance of 55m (180' 5³/₈") before the end and at either end and at the 1.15m (3' 9¹/₄") width of the interior boat guide buoys—are mandatory. Where practical, their use is recommended at all other events.

Slalom Entrance Gate Judgment

Right Hand Gate Buoy

(All references are to the front foot in binding)

Gate Judgement - Right Hand Gate Buoy

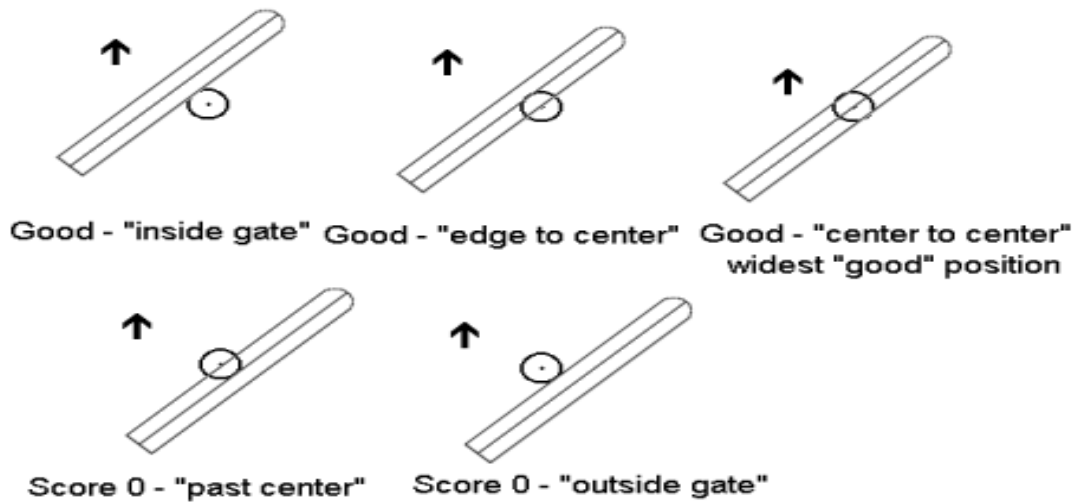

Slalom Scoring Diagram

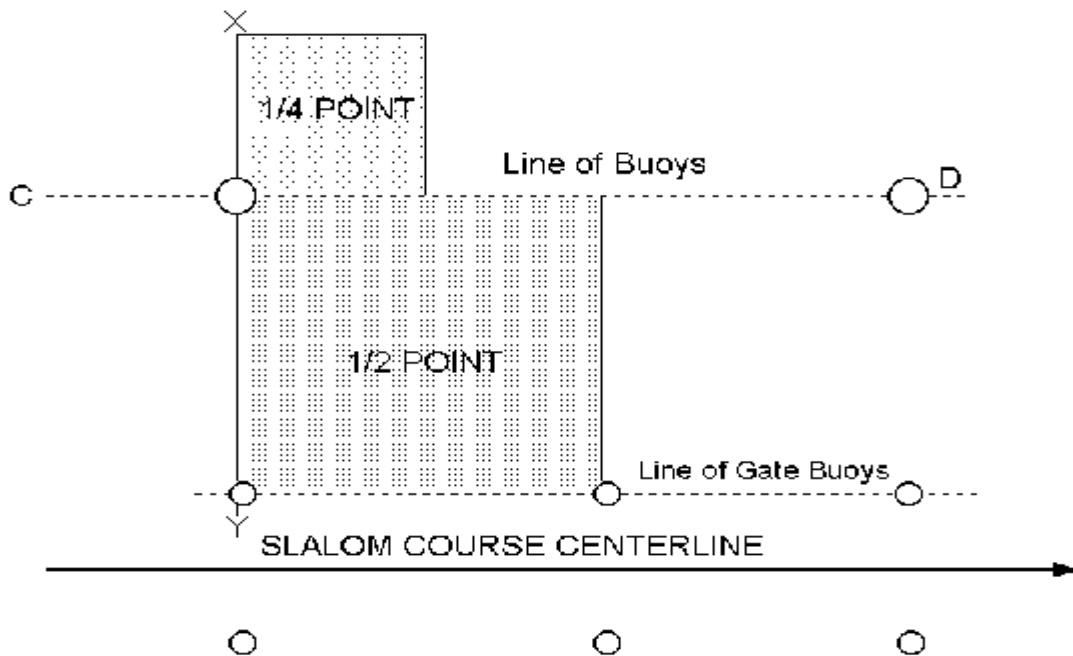

Tow-Pylon Specifications Diagram

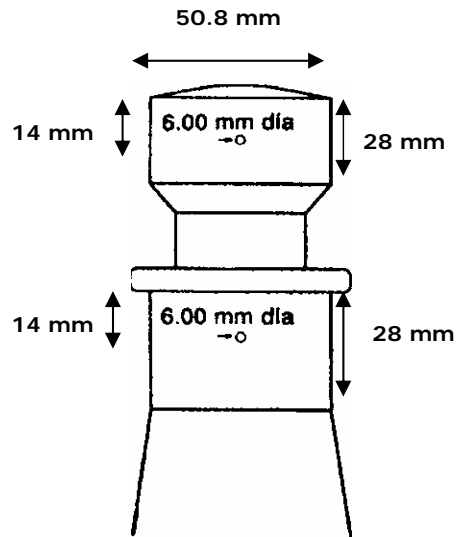

Official Jump Course Diagram

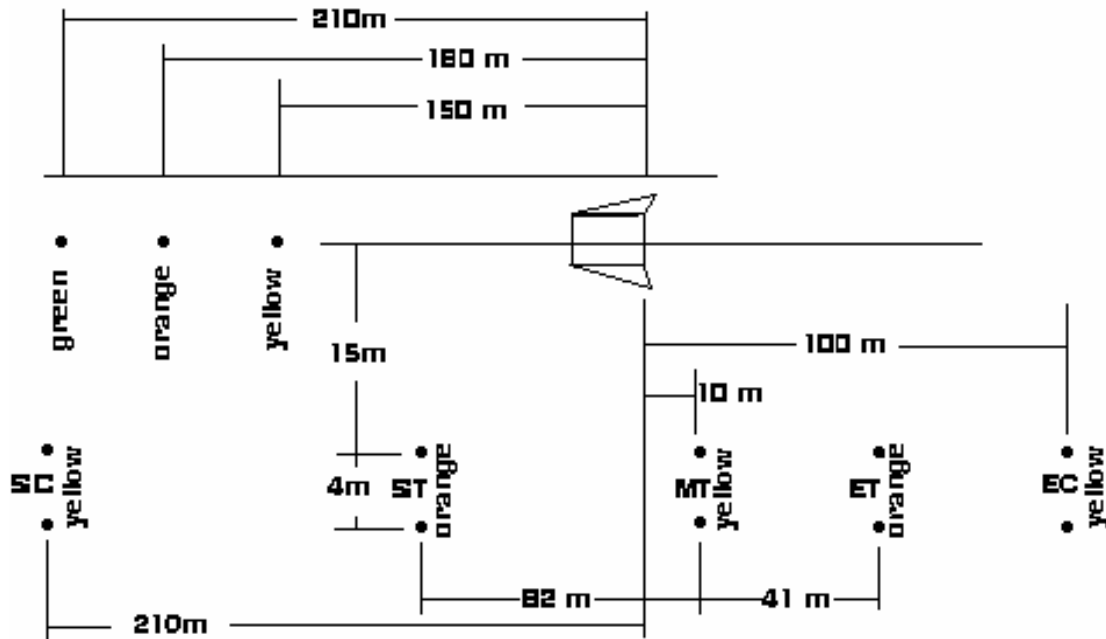

Jump Course Dimensions and Tolerances		
Dimensions	Tolerances	Range
210m (688' 11 ³ / ₄ "	1.0%	207.9m – 212.1m (682' 1" - 695' 10 5/8")
180m (590' 6 ¹ / ₂ "	1.0%	178.2 - 181.8m (584' 7 ³ / ₄ " - 596' 5 ¹ / ₂ "
150m (492' 1 ¹ / ₂ "	1.0%	148.5 - 151.5m (487' 2 ¹ / ₂ " - 497' 1 ¹ / ₂ "
100m (328' 1"		90.0 - 102.0m (301' 8 ¹ / ₄ " - 334' 7 ³ / ₄ "
82m (269' 1 ¹ / ₄ "	0.5%	81.59 - 82.41m (267' 8 ¹ / ₄ " - 270' 4 ¹ / ₂ "
41m (134' 6 ¹ / ₄ "	0.5%	40.795 - 41.205m (133' 10" - 135' 2 ¹ / ₄ "
4m (13' 1 ¹ / ₂ "	2.5%	3.9 - 4.1m (12' 9 ¹ / ₂ " - 13' 5 ¹ / ₂ "
15m (49' 2 ¹ / ₂ "		
to ramp high center	1.0%	14.85 - 15.15m (48' 8 ³ / ₄ " - 49' 8 ¹ / ₂ "
- to 150m, 180m	± .5m	14.50 - 15.50m (47' 6 ³ / ₄ " - 50' 10 ¹ / ₄ "
10m (32' 9 ³ / ₄ "	2%	9.8 – 10.2m (32' 1 ³ / ₄ " - 33' 5 ¹ / ₂ "

The ramp must be parallel to the jump course and slightly open. The tolerance for standard jumping is between +1.00 degrees and +2.50 degrees open, with +2.00 recommended. Open means that the high end of the ramp is turned away from the jump course while the center of the high end remains on the 15m dimension.

The 15 MT buoy may be sunk below 1/2 of its volume. However, it must be clearly visible.

Ramp Setting Chart

Scale: one small division = 1/4 inch

Ramp Setting Chart

Scale: one small division = 1/4 inch

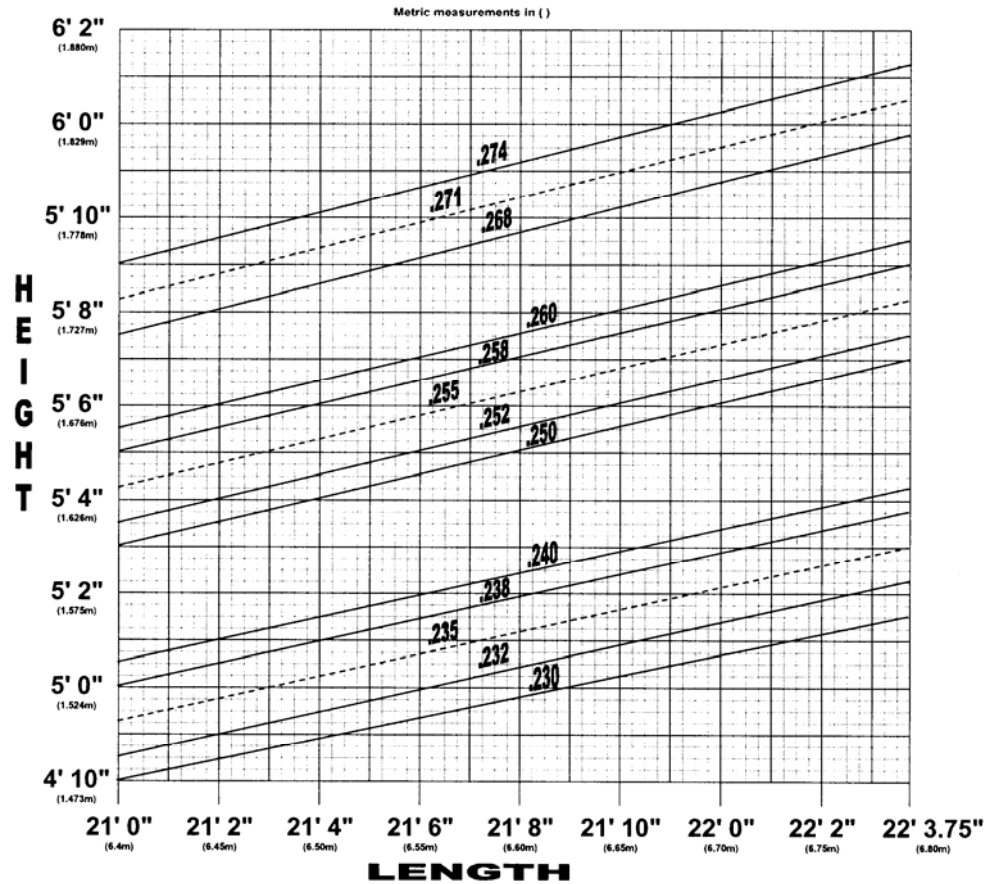

Metric measurements in ()

Length

Instructions: For any particular ramp setting, a combination of HEIGHT at top edge and LENGTH out of water enclosed within the solid line is allowable. A combination that lies on the dotted line is the most desirable. Record Capability standards of $\pm .003$ in ratio are indicated by narrower areas above. Note: Some Open Women may qualify to jump on a .255 ramp, see Rule 9.16c(4).

AWSA Computer Benchmark for Jump Meter Set-up

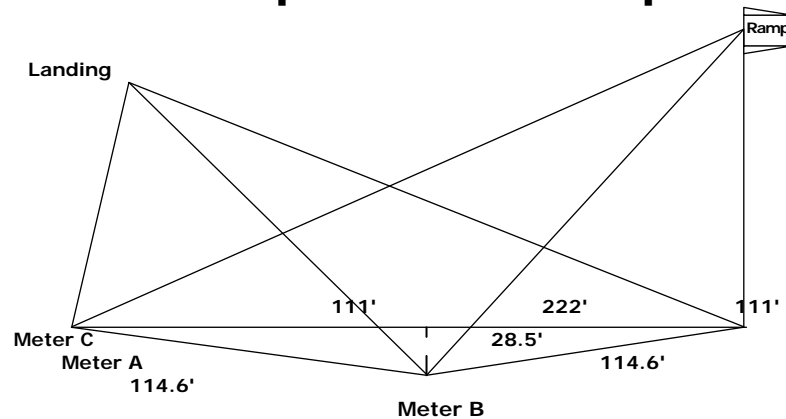

Meter Arrangement	Protractor Alignment
Distance AC = 222 feet Meter B centered between A and C and set back 28.5 feet Distances AB = BC = 114.6 feet Ramp is directly opposite Meter A and 120 feet out	Meter A to Meter B = 180 Meter A to Meter C = 165.6 Meter B to Meter A = 0 Meter B to Meter C = 151.2 Meter C to Meter A = 14.4 Meter C to Meter B = 0

Important Note: The example shown above is theoretical and does not imply that all meter systems must conform to this diagram. It is generally recommended that Meter B be positioned approximately 110 feet ahead of the ramp and, if practical, behind the AC baseline by up to 40 feet. Meters A and C should be equally spaced away from Meter B so that the AC distance is 2 to 2½ times the distance from the center of the AC meter baseline to the center of the landing zone.

The observed meter sightings to the ramp center sighting mark (see Rule 9.16(b)9), and to the 15ET buoy of the timing course, must produce triangles within the tolerances specified in Rule 9.16(a). Computer programs to be used for calculating jump distances must produce the results shown in the meter set-up cases shown below and in the distance calculation cases which appear on the following page.

For the meter and protractor arrangement shown above, the computer should produce the results shown below for the various ramp (upper table) and 15 ET (lower table) sighting angles listed:

Meter A	Meter B	Meter C	Ramp X	Ramp Y	Triangle	Status
75.6	38.823	42.793	0.00	120.00	-0-	Exact
75.6	38.8	42.8	-.04	120.01	.09	Acceptable
75.6	38.7	42.9	-.33	120.34	.67	N/G for RC
75.7	38.7	42.9	-.17	120.20	.76	Too Large

Meter A	Meter B	Meter C	Distance	Triangle	Status
120.28	91.501	86.491	174.40	-0-	Exact
120.3	91.5	86.5	174.40	.07	Acceptable
120.2	91.6	86.4	174.45	.66	N/G for RC
120.2	91.6	86.3	174.22	.81	Too Large

AWSA Computer Benchmark For Jump Distance Calculations

To verify that a computer program in computing distances correctly according to the provisions of Rule 9.12, the operator must show that it produces identical results for all the test cases below, based upon the meter set-up shown on the preceding page. The first set of cases are based on the rules for Class C tournaments or below (see Rules 9.12(b) and 9.12(c)4).

Case	Meter A		Meter B		Meter C		Official Distance	Triangle Size	Notes
	Upper	Lower	Upper	Lower	Upper	Lower			
1	106	Same	58	Same	50.3	Same	67'	-0-	
2	105.13	Same	58	Same	50.3	Same	65'	1.02'	
3	105.14	Same	58	Same	50.3	Same	66'	1.01'	
4	137.9	Same	109	Same	91.7	Same	199'	-0-	
5	137.9	Same	109	Same	93.72	Same	201'	1.70'	
6	137.9	Same	109	Same	93.73	Same	202'	1.71'	
7	126.3	Same	81	Same	60	Same	125'	-0-	
8	126.3	Same	80.1	Same	60	Same	123'	1.65'	
9	126.3	Same	80.11	Same	60	Same	124'	1.63'	
10	126.3	Same	79.93	Same	60	Same	123'	1.96'	
11	126.3	Same	79.92	Same	60	Same	123'	1.97'	Note 1
12	126.3	Same	79.39	Same	60	Same	123'	2.94'	Note 1
13	126.3	Same	79.38	Same	60	Same	W/T	2.96'	121-125 W/T
14	105.57	106.43	57.63	58.37	50.01	50.59	67'	-0-	No spreads
15	105.56	106.44	57.61	58.39	50	50.6	67'	-0-	Uses avgs.
16	106	106.88	58	58.78	50.3	50.9	67'	-0-	Uses uppers
17	106.88	106	58.78	58	50.9	50.3	67'	-0-	Uses lowers
18	106	105.12	58	Same	50.3	Same	66'	.51'	A average
19	106	Same	58	57.23	50.3	Same	66'	.85'	B average
20	106	Same	58	Same	50.3	49.7	67'	.64'	C average
21	137.66	138.14	108.65	109.35	91.18	92.22	199'	-0-	No spreads
22	134.64	138.16	108.64	109.36	91.17	92.23	199'	-0-	Uses avgs.
23	137.9	138.41	109	109.72	91.7	92.77	199'	-0-	Uses uppers
24	100.6	Same	50.6	Same	45.58	Same	51'	-0-	Note 2
25	134.42	Same	100.6	Same	79.4	Same	174'	-0-	Note 2

Note 1: These should not be classified as wide triangles under Class C tournament rules (Rule 9.12(c)4).

Note 2: These are theoretical special cases which may cause difficulty with some computing devices or programs -- consult the AWSA Technical Handbook if either of these cases fails or produces incorrect results.

The additional following test cases must also be run to verify that the special provisions for Record Capability tournaments function correctly (see Rules 9.12(b) and 9.12(c)4):

Case	Meter A		Meter B		Meter C		Distance Ft./m	Triangle Size	Notes
	Upper	Lower	Upper	Lower	Upper	Lower			
26	137.9	Same	109	Same	93.53	Same	201/61.3	1.54'	
27	137.9	Same	109	Same	93.54	Same	201/61.4	1.55'	
28	126.3	Same	79.93	Same	60	Same	123/37.6	1.96'	
29	126.3	Same	79.92	Same	60	Same	W/T	1.97'	Note 3

Note 3: This should be classified as a Wide Triangle, with the short vertex distance at 122 feet (37.2 meters) and the long vertex distance at 125 feet (38.0 meters).

Official Trick Course

The following diagram shows the placement of an optional turn buoy and an optional 50 m pre-start buoy as well as the official trick course. It is highly recommended that the optional buoys be used.

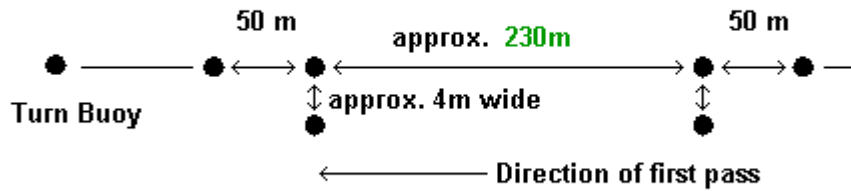

Trick Speed Calibration Times

Times for speedometer calibration at trick speeds are for the speed indicated from the slalom course entry gates to the third buoy (109 m).

Mph	Kph	Ideal	Tolerance
11	17.7	22.17	21.20-23.33
12	19.3	20.32	19.51-21.20
13	20.9	18.76	18.06-19.51
14	22.5	17.42	16.82-18.06
15	24.1	16.25	15.73-16.82
16	25.8	15.24	14.78-15.73
17	27.4	14.34	13.93-14.78
18	29.0	13.55	13.18-13.93
19	30.6	12.83	12.50-13.18
20	32.2	12.19	11.89-12.50
21	33.8	11.61	11.34-11.89

Trick Descriptions and Point Values

DESCRIPTION	WATER TURNS				Trick No.	Trick Code	2 Skis	1 Ski
	Trick No.	Trick Code	2 Skis	1 Ski				
Sideslide	1	S	20*	40*				
Toehold Sideslide	2	TS		130*				
180° FB	3	B	30*	60*	14	WB	50*	80*
180° BF	4	F	30*	60*	15	WF	50*	80*
360° FF	5	O	40*	90*	16	WO	110*	150*
360° BB		BB	40*	90*	17	WBB	110*	150*
540° FB		5B	50	110	18	W5B	310*	310*
540° BF		5F	50	110	19	W5F	310*	310*
720° FF		7F	60	130	20	W7F	800*	800*
720° BB		7B	60	130	21	W7B	480*	480*
900° FB					22	W9B	850*	850*
900° BF						W9F	850*	850*
Stepover 180° FB	6	LB	70*	110	23	WLB	110*	160
Stepover 180° BF	7	LF	70*	110	24	WLF	110*	160
Stepover 360° FF					25	WLO	200*	260*
Stepover 360° BB					26	WLB	200*	260*
Stepover 540° FB					27	WL5B	300*	420*
Double Stepover 540° FB						WL5LB		500*
Stepover 720° FF					27A	WL7F	700*	700*
Stepover 900° FB					27B	WL9B	800*	800*
Stepover 540° BF					28	WL5F	300*	420*
Double Stepover 540° BF						WL5LF		500*
Stepover 720° BB						WL7B	550*	550*
Stepover 900° BF					28A	WL9F	800*	800*
Toehold 180° FB	8	TB		100*	29	TWB		150*
Toehold 180° BF	9	TF		100*	30	TWF		150*
Toehold 360° FF	10	TO		200*	31	TWO		300*
Toehold 360° BB	11	TBB		200*	32	TWBB		330*
Toehold 540° FB	12	T5B		350*	33	TW5B		500*
Toehold 720° FF		T7F		450	35	TW7F		650*
Toehold 540° BF	13	T5F		350	34	TW5F		500
Toehold 720° BB					36	TW7B		650
Toehold Stepover 180° FB					37	TWLB		320
Toehold Stepover 180° BF					38	TWLF		380
Toehold Stepover 360° FF					39	TWLO		480*
Toehold Stepover 360° BB					40	TWLBB		480*
Toehold Stepover 540° FB					41	TWL5B		600*
Toehold Stepover 540° LBF					42	TWL5F		700
Toehold Stepover 720° LFF					42a	TWL7F		800
Somersault Forward					43	FFL	800	800
Somersault Backward					44	BFL	500*	500*
Wake Double Flip					53	DBFL	1,000	1,000
Wake Flip Back Full Twist FF					54	BFLO	800	800*
Wake Flip Back Full Twist BB					56	BFLBB	800	800*
Wake Flip Back Half Twist FB					55	BFLB	750*	750*
Wake Flip Back Line Back					58	BFLB	800	800
Wake Flip Half Twist Front					57	BFLF	550	550*
Wake Flip 540° BF					59	BFL5F	850	850*
Wake Flip 540° FB					60	BFL5B	900	900*
Somersault Forward with 180 Back					61	FFLB	850	850
Somersault Forward with 180 Front					62	FFLF	850	850
Ski Line 180° FB					45	SLB		350*
Ski Line 180° BF					46	SLF		400*
Ski Line 360° FF					47	SLO		400*
Ski Line 360° BB					48	SLBB		450*
Ski Line 540° FB					49	SL5B		550*
Ski Line 540° BF					50	SL5F		550*
Ski Line 720° BB					51	SL7B		750*
Ski Line 720° FF					52	SL7F		800*

*Denotes tricks with allowable reverses. Reverses are the same value as basic trick.

BFL5F and **BFL5B** must be done hand-to-hand. The rope may not be wrapped around the body to assist the turn. This does not prohibit the simple back position wrap where the rope does not go around the body.

Speed Control Parameter Adjustment Chart

Updated speed control parameters may be posted on the USA WS website, accompanied by a revision date, and will supersede the speed control parameters printed in the AWSA Rule Book. No changes shall be made between July 1 and the conclusion of Nationals.

JUMP

Parameter	Who	When	Perfect Pass	Zero Off
BOAT SPEED	Skier	Before each pass	Speed in MPH/KPH	Speed in MPH/KPH
SKIER - JUMP LETTER	Driver/Judge – with input from skier	Before each jump Boat crew may adjust as necessary including for the first jump	Select NEW JUMPER and input speed, skier weight and rated distance. Skier may adjust initial setting +/- 3 letters. Adjust as necessary	Hold "SEL" while jump letter is highlighted Enter skier weight and rated distance. Skier may adjust initial setting +/- 4 letters. Adjust as necessary.
41METER SEGMENT SKIER - FAST or RTB (Return to Baseline)	Skier selects Fast or RTB	Before each skier based on type of 41 meter segment pull requested	S2% - Fast segment = 40 to 60 Return to Baseline = Zero	Letter Only = faster segment Letter with "RTB" above = return to baseline
BOAT ADJUST (Raises speed in the 41 Meter segment. Adds to the target speed)	Driver/Judge	Boat crew may adjust as necessary	S2 FINE – Fine adjust additional RPM as needed to speed up 41Meter segment for actual times.	ADDER - Range = 0 to 9. Start at 0. Adjust as needed for actual times. This number follows "Power Factor". Example: 6/0 - Where 6 is the Power Factor and 0 is the "adder"
BOAT – POWER FACTOR	Driver/Judge – with input from skier	Start at 6 or 7 with 5.7 liter engine Start at 4 with 6.0 liter engine Boat crew may adjust as necessary	N/A	Range 0 to 15 - Raises or lowers the base speed. A lower number result in boat entering the course slower. At 3 or below there is no additional decrease in baseline (adjustments are then made to the ramp rate for the letter)
COUNTER CUT TIME (CT)	Driver	Before event May be adjusted as necessary to control speed during counter cut w/head or tail wind	Recommended: 175 Head Wind 190 Tail Wind 170 ¾ Cut 160	Recommended: 180 Head Wind 190 Tail Wind 170 ¾ Cut 160
CREW WEIGHT	Driver/Judge	Before event	Weight in lbs	N/A
RPM ADJUST	Driver	As needed	Adjust for conditions	N/A
X8u	Skier	The manufacturer's setting may be adjusted up or down within the range as published for that towboat. One additional adjustment may be made after the skier's 1 st jump only.	Controls rate of additional rpm added. With a higher number, it will take longer for the full additional rpm to be reached (softer at the start/stronger at the base).	N/A
X8d	Driver/Judge – with input from skier	The manufacturer's setting may be adjusted up or down within the range as published for that towboat. Before each skier	Controls the timing of the rpm drop once the skier has unloaded the switch. With a higher number, the longer it will take for the boat to begin to slow.	N/A

Speed Control Parameter Adjustment Chart

SLALOM

Parameter	Who	When	Perfect Pass	Zero Off
OPERATING MODE	Driver/Judge	Before event	TOURNAMENT MODE ONLY	TOURNAMENT MODE ONLY
BOAT SPEED	Skier	Before each pass	Speed in MPH/KPH	Speed in MPH/KPH
A1, A2, A3 B1, B2, B3 C1, C2, C3	Skier – skier's option. Set to default - B2 unless skier asks for other setting	Before each pass	N/A	A = Slowest engine response out of buoy B = Moderate engine response out of buoy C = Fastest engine response out of buoy 1 = Softest feel behind the boat 2 = Moderate feel behind the boat 3 = Firmest feel behind the boat
CREW WEIGHT	Driver/Judge	Before event	Enter total crew weight in lbs	N/A
SKIER WEIGHT	Driver/Judge	Before each skier No adjustment between passes	Set skiers weight: Zero = no skier Feather = < 120 lbs Light = 120 to 160 lbs Normal = 160 to 200 lbs X = > 200 lbs	N/A
(PP CLASSIC) KX	Skier – should be set to Normal unless skier asks for other setting	Before each pass	KX - = softer KX NORMAL = default KX + / KX++ = firmer	N/A
(PP CLASSIC) PX	Skier – should be set to zero unless skier asks for other setting	Before each skier No adjustment between passes	PX = 0 to 40 Zero eliminates the switch	N/A
(PP CLASSIC) RPM ADJUST	Driver	Adjust as necessary for conditions	Adjust for conditions	N/A
(PP CLASSIC) SSB	Driver	Adjust as necessary to balance speed between first and second segments of the course	Initial setting for each boat from mfg suggested settings - adjust as needed	N/A

TRICKS

Parameter	Who	When	Perfect Pass	Zero Off
BOAT SPEED	Skier	Before each pass	Speed in MPH/KPH	Speed in MPH/KPH
A1, A2, A3 B1, B2, B3 C1, C2, C3	Skier – skier's option. Set to default - B2 unless skier asks for other setting	Before each pass	N/A	See ABC in slalom Above
Kd	Skier – skier's option. Set to default - unless skier asks for other set- ting	Before each pass	Default = 28	N/A

NOTE: If the designated towboat has multiple GPS systems available, the skier has the option to select from available GPS systems. If the tournament committee chooses to use older Perfect Pass Classic, then no choice is permitted.

Jumping Event Timing Tolerance Table

Jumping Event Timing Tolerance Table										
RECORD	Boat Speed		1st Segment Times				2nd Segment Times**			
Tolerances	Kph	Mph	Balk	Fast	Ideal	Slow	Fast	Ideal	Slow	RTB*
Apply only when the skier is at the maximum speed for his/her age division, otherwise use the table below.	57	35.4	5.06	5.11	5.18	5.25	2.36	2.40	2.466	2.71
	54	33.6	5.34	5.39	5.47	5.55	2.54	2.59	2.66	2.86
	51	31.7	5.65	5.70	5.79	5.88	2.68	2.73	2.81	3.01
	48	29.8	6.00	6.05	6.15	6.25	2.84	2.89	2.98	3.18
	45	28.0	6.40	6.45	6.56	6.68	3.01	3.08	3.17	3.37
	Tolerance basis:			+/- 0.8 kph (0.50 mph)			+1/-1.5 kph (+0.62/-0.93 mph)			
STANDARD	Boat Speed		1st Segment Times				2nd Segment Times**			
Tolerances	Kph	Mph	Balk	Fast	Ideal	Slow	Fast	Ideal	Slow	RTB*
Apply these tolerance values at most Class C tournaments, and in Record tournaments where the skier is at speeds lower than the maximum for his/her age division.	57	35.4	5.02	5.07	5.18	5.29	2.36	2.40	2.48	2.73
	54	33.6	5.30	5.35	5.47	5.59	2.54	2.59	2.68	2.88
	51	31.7	5.60	5.65	5.79	5.93	2.68	2.73	2.84	3.04
	48	29.8	5.95	6.00	6.15	6.31	2.84	2.89	3.01	3.21
	45	28.0	6.34	6.39	6.56	6.74	3.01	3.08	3.21	3.41
	42	26.1	6.78	6.83	7.03	7.24	3.21	3.28	3.43	3.63
	39	24.2	7.29	7.34	7.57	7.81	3.43	3.51	3.69	3.89
	Tolerance basis:			+/- 1.21 kph (0.75 mph)			+1/-2.0 kph (+0.62/-1.24 mph)			

****Note:** The above 2nd Segment boat speed tolerances presume that the boat speed will rise to 3 kph faster than the baseline speed once the skier is in the air (except 4.5 kph faster at 57 kph/"35" mph).

*Alternatively, use the "RTB" slow time limit if the skier chooses the "return to baseline speed" basis, or is not sufficiently aggressive to engage the jump switch at the base of the ramp. If a skier who selects the faster second segment does not properly engage the switch at the ramp, then the tolerance as indicated in the RTB column applies.

If the skier balks, examine only the 1st segment time against this table. See Rule 9.09(a).

Slalom Timing Chart

Standard Tolerance ABT Chart

(Required in Class C or E. See IWSF Rules for Class L or R Events)

BOAT SPEED		Score:	0-0.5	1-1.5	2-2.5	3-3.5	4-4.5	5-5.5	All 6
KPH	MPH	Display	0	1	2	3	4	5	6
58	36.0	Fast	1.64	4.15	6.67	9.20	11.73	14.25	15.92
		Ideal	1.68	4.22	6.77	9.31	11.86	14.40	16.08
		Slow	1.71	4.28	6.84	9.41	11.97	14.53	16.22
55	34.2	Fast	1.73	4.37	7.03	9.69	12.35	15.02	16.78
		Ideal	1.77	4.45	7.13	9.82	12.50	15.19	16.95
		Slow	1.80	4.51	7.23	9.93	12.64	15.34	17.12
52	32.3	Fast	1.83	4.62	7.43	10.24	13.05	15.87	17.72
		Ideal	1.87	4.71	7.55	10.38	13.22	16.06	17.93
		Slow	1.91	4.78	7.65	10.52	13.39	16.25	18.13
49	30.4	Fast	1.94	4.90	7.87	10.85	13.83	16.81	18.78
		Ideal	1.98	5.00	8.01	11.02	14.03	17.04	19.03
		Slow	2.03	5.08	8.13	11.18	14.22	17.27	19.27
46	28.6	Fast	2.06	5.21	8.37	11.54	14.71	17.88	19.98
		Ideal	2.11	5.32	8.53	11.74	14.95	18.16	20.27
		Slow	2.16	5.42	8.68	11.93	15.18	18.42	20.56
43	26.7	Fast	2.20	5.56	8.94	12.33	15.71	19.10	21.34
		Ideal	2.26	5.69	9.13	12.56	15.99	19.42	21.68
		Slow	2.32	5.81	9.30	12.78	16.27	19.75	22.03
40	24.9	Fast	2.36	5.97	9.60	13.23	16.86	20.50	22.89
		Ideal	2.43	6.12	9.81	13.50	17.19	20.88	23.31
		Slow	2.50	6.26	10.02	13.78	17.53	21.27	23.74
37	23.0	Fast	2.54	6.44	10.35	14.27	18.19	22.11	24.70
		Ideal	2.63	6.62	10.61	14.59	18.58	22.57	25.20
		Slow	2.71	6.79	10.86	14.93	18.99	23.06	25.73
34	21.1	Fast	2.76	6.99	11.24	15.49	19.74	23.99	26.81
		Ideal	2.86	7.20	11.54	15.88	20.22	24.56	27.42
		Slow	2.95	7.41	11.85	16.29	20.73	25.16	28.08
31	19.3	Fast	3.02	7.65	12.29	16.93	21.58	26.24	29.31
		Ideal	3.14	7.90	12.66	17.42	22.18	26.94	30.08
		Slow	3.25	8.15	13.05	17.93	22.82	27.70	30.90
28	17.4	Fast	3.33	8.43	13.55	18.68	23.81	28.94	32.33
		Ideal	3.47	8.74	14.01	19.29	24.56	29.83	33.30
		Slow	3.61	9.07	14.51	19.94	25.37	30.80	34.37
25	15.5	Fast	3.71	9.40	15.11	20.83	26.54	32.26	36.04
		Ideal	3.89	9.79	15.70	21.60	27.50	33.41	37.30
		Slow	4.07	10.21	16.34	22.46	28.58	34.68	38.70

Slalom Timing Chart

Wide Tolerance ABT Chart

(For use in Class N and below events)

BOAT SPEED		Score:	0-0.5	1-1.5	2-2.5	3-3.5	4-4.5	5-5.5	All 6
KPH	MPH	Display	0	1	2	3	4	5	6
58	36.0	Fast	1.63	4.14	6.65	9.17	11.69	14.21	15.87
		Ideal	1.68	4.22	6.77	9.31	11.86	14.40	16.08
		Slow	1.72	4.29	6.87	9.44	12.01	14.58	16.27
55	34.2	Fast	1.72	4.36	7.00	9.65	12.30	14.96	16.71
		Ideal	1.77	4.45	7.13	9.82	12.50	15.19	16.95
		Slow	1.82	4.53	7.25	9.97	12.69	15.40	17.19
52	32.3	Fast	1.82	4.60	7.40	10.19	12.99	15.79	17.65
		Ideal	1.87	4.71	7.55	10.38	13.22	16.06	17.93
		Slow	1.92	4.80	7.69	10.57	13.45	16.32	18.21
49	30.4	Fast	1.92	4.87	7.83	10.80	13.76	16.73	18.69
		Ideal	1.98	5.00	8.01	11.02	14.03	17.04	19.03
		Slow	2.05	5.11	8.18	11.24	14.30	17.36	19.37
46	28.6	Fast	2.05	5.18	8.33	11.47	14.63	17.78	19.86
		Ideal	2.11	5.32	8.53	11.74	14.95	18.16	20.27
		Slow	2.18	5.46	8.73	12.00	15.27	18.54	20.68
43	26.7	Fast	2.18	5.53	8.88	12.24	15.61	18.98	21.20
		Ideal	2.26	5.69	9.13	12.56	15.99	19.42	21.68
		Slow	2.34	5.85	9.37	12.87	16.38	19.89	22.18
40	24.9	Fast	2.34	5.92	9.52	13.13	16.73	20.34	22.72
		Ideal	2.43	6.12	9.81	13.50	17.19	20.88	23.31
		Slow	2.52	6.31	10.10	13.89	17.67	21.44	23.93
37	23.0	Fast	2.52	6.38	10.26	14.14	18.03	21.92	24.49
		Ideal	2.63	6.62	10.61	14.59	18.58	22.57	25.20
		Slow	2.74	6.85	10.96	15.07	19.17	23.26	25.96
34	21.1	Fast	2.74	6.92	11.13	15.33	19.55	23.76	26.54
		Ideal	2.86	7.20	11.54	15.88	20.22	24.56	27.42
		Slow	2.99	7.49	11.98	16.47	20.95	25.43	28.37
31	19.3	Fast	2.99	7.56	12.14	16.74	21.34	25.94	28.97
		Ideal	3.14	7.90	12.66	17.42	22.18	26.94	30.08
		Slow	3.29	8.25	13.21	18.16	23.10	28.04	31.29
28	17.4	Fast	3.29	8.32	13.37	18.43	23.49	28.56	31.91
		Ideal	3.47	8.74	14.01	19.29	24.56	29.83	33.30
		Slow	3.67	9.20	14.72	20.23	25.74	31.25	34.86
25	15.5	Fast	3.67	9.26	14.87	20.50	26.13	31.77	35.49
		Ideal	3.89	9.79	15.70	21.60	27.50	33.41	37.30
		Slow	4.14	10.39	16.62	22.84	29.06	35.27	39.36

AWSA National Championships Event Classification

As Revised and Approved by the AWSA Board of Directors, June 6, 2003

DIVISIONS	Slalom	Trick	Jump
B1/G1	E	E	
B2/G2	E	L	L
B3/G3	L	L	L
M1/W1	L	L	L
M2/W2	L	L	L
M3/M4	E	L	L
W3/W4	L	L	L
M5/W5	E	E	E
M6-10/W6-10	E	E	E
MM	E	L*	L*
OM/OW	R	R	R

**Recommended by the Rules committee 3-20-09*

Rules Jurisdiction Chart

Rule Number	Rule Description	Jurisdiction	Coordinating Committee
1	General	Rules	
1.14	Tournament Sanction Review	Rules	Technical
2	Tournament Events, etc	Rules	
3	Division Competition Rankings	Rules	Skiers Qualification
4	Tournament Qualifications	Rules	Skiers Qualification
5	Overall & Team Competition	Rules	Skiers Qualification
6	Officials	Rules	
6.01a,b, c, f & g	National Tournament Officials	Judges & Scorers	
6.01 d & e	National Tournament Drivers	Boat Drivers	
6.01 h	National Tournament Safety Directors	Safety	
6.01 i	National Tournament Technical Controller	Technical	
6.02a,b, c & e	Regional Tournament Officials	Judges & Scorers	
6.02 d	Regional Tournament Drivers	Boat Drivers	
6.02 f	Regional Tournament Safety Directors	Safety	
6.02 g	Regional Tournament Technical Controller	Technical	
6.03a,b, d, e & f	Regional Tournament Officials	Judges & Scorers	
6.03 c	Regional Tournament Drivers	Boat Drivers	
6.03 g	Regional Tournament Safety Directors	Safety	
6.03 h	Regional Tournament Technical Controller	Technical	
6.10, 6.11 & 6.13	Judges and Emeritus	Judges & Scorers	
7	Rerides, Protests & Disqualification	Rules	
8	Equipment & Definitions		
8.01	Competition Area	Technical	
8.02	Boats	Rules	Tow Boat
8.03	Skis	Technical	
8.04	Tow Lines	Technical	
8.05	Boat Speeds	Rules	Technical
8.06	A Fall	Rules	
8.07	Skiing Position	Rules	
8.08	The Wake	Rules	
8.09	Buoys	Technical	
8.10	Speed Control	Rules	Technical/Towboat
9	Jumping	Rules	
9.09b & c	Timing	Rules	Technical
9.12	Distance Measurement	Technical	
9.16	Jumping Equipment and Definitions	Technical	
9.17	Tolerances	Technical	Rules
10	Slalom	Rules	Technical
10.02	Slalom Course	Technical	

Rule Number	Rule Description	Jurisdiction	Coordinating Committee
10.06c	Rope Lengths/Tolerances	Technical	Rules
10.09b	Timing	Rules	Technical
10.16	Slalom Equipment and Definitions	Technical	
10.17	Tolerances	Technical	Rules
11	Tricks	Rules	Technical
11.02	Trick Course	Technical	
11.09b	Timing	Rules	Technical
11.17	Speed Calibration	Technical	
12	Safety Requirements	Safety	
13	Optional Tournament Formats	Rules	
14	Records	Technical	
14.01	AWSA Recognition	Technical	
14.02	Performance Requirements	Rules	
15	Record Capability Tournaments	Rules	
15.03	Certification of Competition Courses	Technical	
15.04	Technical Controller	Technical	
15.06	Technical Requirements	Technical	
16	Cash Prize Tournaments	AWSA Executive Committee & AWSA Board	
17	Ski Flying	Rules	Technical
Appendix	Rules Interpretations	Rules	
Appendix	Optional 2-Segment Timing Rules	Rules	
Appendix	IWSF/AWSA Rule Differences	Rules	
Appendix	Official Development Program	All Officials Committees	
Appendix	Tow Line Dimensions	Technical	
Appendix	Official Slalom Course Diagram	Technical	
Appendix	Slalom Scoring	Rules	
Appendix	Tow-pylon Specifications Diagram	Technical	
Appendix	Off Jump Course Diagram	Technical	
Appendix	Ramp Setting Chart	Technical	
Appendix	Computer BMK Meters	Technical	
Appendix	Computer BMK Calculations	Technical	
Appendix	Official Trick Course	Technical	
Appendix	Trick Speed Calibration Times	Technical	
Appendix	Trick Description & Point Values	Rules	
Appendix	Tournament Classification Requirements	AWSA & IWSF	
Appendix	Speed Control Parameter Adjustment Chart	Rules	Towboat
Appendix	Jump Timing Tables	Technical	
Appendix	Slalom Timing Tables	Technical	
Appendix	Nationals Event Classifications	AWSA Board	Rules
Appendix	Rules Jurisdiction Chart	AWSA Board	Rules

This table is designed to indicate which committee is responsible for a particular rule. In cases where a specific rule number within the broader rule number is listed, the committee with jurisdiction is responsible for the specific rule number, not the committee with the broader responsibility. In cases where a coordinating committee is listed, it will provide support and guidance to the primary committee on the portion of that particular rule.

Tournament Classification Requirements

Tournament Classification	Regular Local Class C	National Entry Class E	Ranking List Class L	World Record Class R
Applicability				
AWSA National Records	No	Yes	Yes	Yes
IWSF Ranking List	No	No	Yes	Yes
World Records	No	No	No	Yes
General Requirements				
Chief Officials				
Judge	Reg. or Sr.	Sr.	Sr. (W)	Sr. (W)
Scorer	Reg. or Sr.	Sr.	Sr. (A)	Sr. (A)
Driver	Reg. or Sr.	Sr.	Sr. (A)	Sr. (A)
Safety Director	State	State	State	State
Technical Controller	No	Yes	Yes (W)	Yes (W)
Appointed Judges	3	5	5 (A) 1 Pan-Am (P)	5 (A) 1 Pan-Am (P)
Conflict of Interest Rule	No	Yes	Yes (A)	Yes (A)
Site Certification	Measured	Survey	Survey (W)	Survey (W)
Judges Towers	3m high, both sides recom.	3m/44° both sides	3m/44° both sides	3m/44° both sides
Trick Timing Devices	Manual	Automatic	Automatic (W)	Automatic (W)
Speed Control	Yes	Yes	Yes	Yes
Slalom Requirements				
End Course Video	No	Yes	Yes (A)	Yes (A)
Minimum Avg. Buoy Width	None	11.48m	11.48m (W)	11.48m (W)
Event Judges	5 (or 3) Ast. or up	5 Total, min 1 R/S each tower and Towboat	5 total, min. 3 Sr. (W)	5 Sr. (W)
Optional Video EJ's	Same	3 Reg. or Sr.	2 Sr. & 1 Reg. (W)	3 Sr. (W)
Tricks Requirements				
Video	Recommended	Required	Required (W)	Required (W)
Event Judges	5 (or 3) Ast. or up	5 Reg. or Sr.	5 total, at least 3 Sr. (W)	5 Sr. (W)
EJ's w/ immediate Video	Same	3 Reg. or Sr.	3 Sr. (W)	3 Sr. (W)
Boat Judge	Ast.	Ast. or up or Reg or Sr Driver	Reg. (A)	Reg. (W)
Shore Timer	Ast. Recom.	Reg. or Sr.	Reg. or Sr. (W)	Reg. or Sr. (W)
Backup Timer	Ast. Recom.	Ast. or up	Reg. or Sr. (W)	Reg. or Sr. (W)
Jumping Requirements				
Video	No	No	Required (W)	Required (W)
Distance Calc. Method	M/B or Comp.	Computer	Computer (W)	Computer (W)
Event Judges	3 Ast. or up	3 Reg. or Sr.; 1 Shore may be ast.	3 total, at least 2 Sr. (W)	3 Sr. (W)
Meter Readers	2 (or 1) Ast. or up recommended	2 each, with 1 Reg. or Sr.	2 each, with 1 Reg. or Sr. (A)	2 each, with 1 Reg. or Sr. (W)
Notes: (W) as required by IWSF World Rules. (P) as required by IWSF Pan-American Region Rules. (A) as required by AWSA Rules, which are more requiring than the associated Pan-American or World rules (if any).				



PREMIER SPONSORS



Overton's[®]

MasterCraft

The leader. And pulling further ahead.



Indmar

Marine Engines

